



# USPSA Handgun Competition Rules February 2014



© Copyright 2014 by USPSA®/IPSC, Inc.  
Burlington, WA 98233



## **PRINCIPLES of USPSA Competitions**

1. Practical competition is open to all reputable persons without regard to occupation. It may specifically not be limited to public servants.
2. Accuracy, power and speed are the equivalent elements of practical shooting and practical competition must be conducted in such a way as to evaluate these elements equally.
3. Firearm types are not separated within their respective divisions, all compete together without handicap. This does not apply to the power of the firearms as power is an element to be recognized and rewarded.
4. Practical shooting competition is a test of expertise in the use of practical firearms and equipment.
5. Practical competition is conducted using practical targets, which reflect the general size and shape of such objects as the firearm used may reasonably be called upon to hit in their primary intended use.
6. The challenge presented in practical competition must be done with the utmost safety in mind. Courses of Fire should follow a practical rationale and simulate hypothetical situations in which firearms might reasonably be used.
7. Practical competition is diverse, never permitting unrealistic specialization of either technique or equipment. Problems are constantly changed. The exception is Classifier Stages which are used to measure practical shooting skill.
8. Practical competition is free-style. In essence, the competitive problem is posed in general and the participant is permitted the freedom to solve it in the manner he considers best within the limitations of the competitive situation as provided.

## **The USPSA Classification System**

Grand Master	95 to 100%
Master	85 to 94.9%
A Class	75 to 84.9%
B Class	60 to 74.9%
C Class	40 to 59.9%
D Class	Below 40%

Your percentage is based on your scores as they relate to the high score on file for a particular course of fire. To receive an initial classification, a member needs to have at least four unduplicated scores in the USPSA classification database prior to the monthly reclassification procedure. If there are more than four scores on file, the best four scores of the most recent six scores will be used. Scores are sorted according to the match date to determine which scores are the most recent. For matches that are Level I Specials, the scores are further sorted by the score percent in descending order. In doing so, the lowest scores from a special will be the first scores to drop out of the most recent scores on file.

After a member has earned a classification, the classification system will look at the best six unduplicated scores of the most recent eight to evaluate the member's current classification percentage.

No scores that calculate to less than 2 percent are used. Also, to prevent unusually low scores from affecting your classification percentage, scores that are more than 5 percent below your classification bracket (e.g. a score of 34.99% for a C-class competitor) are not used for classification purposes. To guard against the possibility of incorrect stage setup or typographical error, scores that are more than 15 percent above your current classification bracket are evaluated at the time of entry to see if such a score would adversely affect your classification. In general, those scores are entered, but occasionally a score is so out of the ordinary it is not used and flagged with an A.

So members can keep track of their scores, all scores received are entered into the database, but may be given a "flag" to indicate its status. The possible flags are:

- A — A score that is more than 15% above the member's current classification bracket.
- B — A score that is more than 5% below the member's current classification bracket.
- C — A score that is more than one class below the highest class in any division attained by the member. e.g. A member has a Master class in Open division and a B class score in Limited is submitted. This score will be flagged with C and not used.
- D — Duplicate course - a higher score for this course already exists in the most recent six or eight scores.
- E — A score that is not in the most recent six or eight scores.
- F — A score that is one of the two lowest scores in the most recent six or eight scores.
- Y — A score that has been used as part of the classification percentage calculation.

Please note that for unclassified members, the first scores submitted, except for those that are 2 percent or less, will be used to calculate an initial classification.

After a classification has been earned in a division, new scores will be evaluated according to the flagging system shown above. This can and does result in new scores not being used for reclassification purposes even though they are higher than some of the initial scores that were submitted, but still lower than your classification bracket. Any such low score should move out of the most recent group as newer scores that conform to your current classification are entered into the system.

The classification system is run between the 10th and the 15th of each month, depending on whether the 10th is on a weekend. ALL scores received in the Sedro Woolley office on or before the 10th of each month are entered into the classification database. Over the next day or two, those scores are checked to ensure that they were entered correctly from the printed summary sheets submitted by clubs. After any corrections have been made, the computer classification program is started to evaluate each member's current scores and to calculate a new current classification percentage. At the conclusion of this procedure, the new data is compiled and sent to the USPSA web site. Please note that the classification data on the web site is updated only one time each month.

If you feel your classification is too low, you may request the next higher class, up to but not including Grand Master. Requests are made in writing and submitted with a letter from your club president or Section Coordinator (SC) endorsing your request. If your request is approved, you will be moved up at the next regular calculation period.

Your performance in larger matches and tournaments may also be used to help establish classification. Placement in a major event with a score above your assigned class percentage may result in your being promoted to a higher class, even if your current average is lower. Winning first or second in class at an Area Championship or Major Tournament AND shooting into the next higher class may result in promotion (except to Grand Master); winning High Overall in an Area Championship may promote you to Grand Master class. In addition, if you score 95% or higher at a USPSA national championship, you will be immediately moved to Grand Master class for that division.

To go down in class you must: 1) request in writing to be moved down, citing your reasons and justification; 2) have a club president or SC concur with your request in writing; and 3) have no current scores on record that indicate you should remain in your assigned class.

You may also participate in the classification system if you are a USPSA member living outside the United States by forming, or shooting with one of our foreign affiliate clubs. Foreign affiliate clubs need to request a special registration form from USPSA headquarters and pay a yearly registration fee for this service. Members shooting outside the United States do not pay individual classification fees and do not earn activity credit to attend the Nationals.



# TABLE OF CONTENTS

<b>CHAPTER 1 – Course Design</b>	<b>Page No.</b>
1.1 General Principles .....	4
1.2 Types of Courses .....	5
1.3 USPSA Sanctioning.....	6
<b>CHAPTER 2 – Course Construction and Modification</b>	
2.1 General Regulations .....	7
2.2 Course Construction Criteria.....	9
2.3 Modifications to Course Construction.....	10
2.4 Safety Areas .....	12
2.5 Unloading/Loading Station .....	12
<b>CHAPTER 3 – Course Information</b>	
3.1 General Regulations.....	13
3.2 Written Stage Briefings .....	13
3.3 Applicability of Rules.....	14
<b>CHAPTER 4 – Range Equipment</b>	
4.1 Targets – General Principles.....	14
4.2 Approved Handgun Targets – Paper .....	15
4.3 Approved Handgun Targets – Metal .....	16
4.4 Frangible and Synthetic Targets .....	17
4.5 Rearrangement of Range Equipment or Surface .....	17
4.6 Range Equipment Failure and Other Issues.....	18
<b>CHAPTER 5 – Competitor Equipment</b>	
5.1 Handguns.....	18
5.2 Holsters and Other Competitor Equipment .....	19
5.3 Appropriate Dress.....	21
5.4 Eye and Ear Protection .....	22
5.5 Ammunition and Related Equipment .....	22
5.6 Chronograph and Power Factors .....	23
5.7 Malfunctions – Competitor's Equipment.....	23
5.8 Official Match Ammunition .....	24
<b>CHAPTER 6 – Match Structure</b>	
6.1 General Principles .....	25
6.2 Match Divisions .....	26
6.3 Match Categories.....	27
6.4 Competitor Status and Credentials .....	27
6.5 Competitor Scheduling and Squadding .....	27

## **CHAPTER 7 – Match Management**

7.1 Match Officials.....	28
7.2 Discipline of Match Officials .....	29
7.3 Appointment of Officials.....	29

## **CHAPTER 8 – The Course of Fire**

8.1 Handgun Ready Conditions.....	30
8.2 Competitor Ready Condition.....	31
8.3 Range Communication .....	31
8.4 Loading, Reloading or Unloading During a Course of Fire .....	33
8.5 Movement.....	33
8.6 Assistance or Interference .....	33
8.7 Sight Pictures and Range Inspection .....	34

## **CHAPTER 9 – Scoring**

9.1 General Regulations .....	34
9.2 Scoring Methods.....	36
9.3 Scoring Ties.....	37
9.4 Scoring and Penalty Values.....	38
9.5 Scoring Policy .....	38
9.6 Score Verification and Challenge.....	39
9.7 Score Sheets .....	40
9.8 Scoring Responsibility.....	41
9.9 Scoring of Moving Targets.....	42
9.10 Official Time .....	42
9.11 Scoring Programs .....	43

## **CHAPTER 10 – Penalties**

10.1 Procedural Penalties – General Regulations.....	43
10.2 Procedural Penalties – Specific Examples.....	44
10.3 Match Disqualification – General Regulation .....	46
10.4 Match Disqualification – Accidental Discharge .....	46
10.5 Match Disqualification – Unsafe Gun Handling .....	47
10.6 Match Disqualification – Unsportsmanlike Conduct.....	49
10.7 Match Disqualification – Prohibited Substances .....	49

## **CHAPTER 11 – Arbitrations and Interpretation of Rules**

11.1 General Principles .....	50
11.2 Composition of Committee .....	51
11.3 Time Limits and Sequences.....	51
11.4 Fees.....	52
11.5 Rules of Procedure .....	52
11.6 Verdict and Subsequent Action .....	52



11.7	Third Party Appeals.....	53
11.8	Interpretation of Rules.....	53
<b>CHAPTER 12 – Miscellaneous Matters</b>		
12.1	Appendices .....	53
12.2	Language .....	53
12.3	Disclaimers.....	54
12.4	Gender .....	54
12.5	Measurements.....	54
Appendix A1	– USPSA Match Levels .....	55
Appendix A2	– USPSA Recognition.....	56
Appendix A3	– Glossary .....	57
Appendix B1	– Target Presentation.....	61
Appendix B2	– Classic Target.....	62
Appendix B3	– Metric Target.....	64
Appendix B4	– Popper Calibration Zone .....	65
Appendix B5	– Metal Plates .....	66
Appendix C1	– Calibration of Poppers.....	67
Appendix C2	– Match Chronograph and Equipment Set-up .....	69
Appendix C3	– Official Match Ammunition .....	75
Appendix D1	– Open Division .....	76
Appendix D2	– Limited Division .....	77
Appendix D3	– Limited-10 Division .....	78
Appendix D4	– Production Division .....	79
Appendix D5	– Single-Stack Division.....	85
Appendix D6	– Revolver Division .....	88
Appendix E1	– Magazine Measurement Procedure.....	89
Appendix E2	– Holster and Magazine Position.....	91
Appendix E3	– Diagram of Equipment Position .....	92
Appendix E4	– Checkering, Stippling, and Grip Tape .....	93
Appendix F1	– Vendors Area .....	94
INDEX.	.....	95

# CHAPTER 1: Course Design

The following general principles of course design list the criteria, responsibilities and restrictions governing course designers as the architects of the sport of USPSA shooting.

## 1.1 General Principles

- 1.1.1 Safety – USPSA matches must be designed, constructed and conducted with due consideration to safety.
- 1.1.2 Quality – The value of an USPSA match is determined by the quality of the challenge presented in the course design. Courses of fire must be designed primarily to test a competitor’s USPSA shooting skills, not their physical abilities.
- 1.1.3 Balance – Accuracy, Power and Speed are equivalent elements of USPSA shooting, and are expressed in the Latin words “Diligentia, Vis, Celeritas” (“DVC”). A properly balanced course of fire will depend largely upon the nature of the challenges presented therein, however, courses must be designed, and USPSA matches must be conducted in such a way, as to evaluate these elements equally.
- 1.1.4 Diversity – USPSA shooting challenges are diverse. While it is not necessary to construct new courses for each match, no single course of fire must be repeated to allow its use to be considered a definitive measure of USPSA shooting skills.
- 1.1.5 Freestyle – USPSA matches are freestyle. Competitors must be permitted to solve the challenge presented in a freestyle manner, and to shoot targets on an “as and when visible” basis. Courses of fire must not require mandatory reloads nor dictate a shooting position, location or stance, except as specified below. However, conditions may be created, and barriers or other physical limitations may be constructed, to compel a competitor into shooting positions, locations or stances.
  - 1.1.5.1 Level I matches may use shooting boxes, specify where or when specific target arrays may be engaged and specify mandatory reloads in short and medium courses only. Long courses are exclusively governed by 1.1.5.
  - 1.1.5.2 Standard Exercises and Classifiers may include mandatory reloads and may dictate a shooting position, location or stance.
  - 1.1.5.3 Standard Exercises and Classifiers may specify shooting with the strong hand or weak hand unsupported. The specified hand must be used exclusively from the point stipulated for the remainder of the string or stage.
  - 1.1.5.4 Medium or Long courses of fire may stipulate the use of either strong or weak hand, provided that only one hand, either strong or weak, is specified for no more than the last 6 shots required.

- 1.1.5.5 A course of fire which, through the use of props, requires a competitor to shoot both strong-hand-only and weak-hand-only must not require that the shooter transition directly from one to the other. The course of fire must provide movement and unencumbered freestyle target engagement between the two.
- 1.1.6 Difficulty – USPSA matches present varied degrees of difficulty. No shooting challenge or time limit may be appealed as being prohibitive. This does not apply to non-shooting challenges, which should reasonably allow for differences in competitor’s height and physical build.
- 1.1.7 Challenge – USPSA Handgun matches recognize the difficulty of using full power handguns in dynamic shooting, and must always employ a minimum caliber and power level to be attained by all competitors to reflect this challenge.
- 1.1.8 Scenarios and Stage Props — The use of scenarios and reasonable stage props is encouraged. Care must be exercised, however, to avoid unrealistic non-shooting requirements which detract from the shooting challenge and/or may expose competitors to potentially unsafe conditions.

## 1.2 Types of Courses

USPSA matches may contain the following types of courses of fire:

### 1.2.1 General Courses of Fire:

- 1.2.1.1 **Short Courses:** must not require more than 12 rounds to complete and no more than 2 shooting locations. Course design and construction must not require more than 8 scoring hits from any single location or view, nor allow a competitor to shoot all targets in the course of fire from any single location or view.
- 1.2.1.2 **Medium Courses:** must not require more than 20 rounds to complete and no more than 3 shooting locations. Course design and construction must not require more than 8 scoring hits from any single location or view, nor allow a competitor to shoot all targets in the course of fire from any single location or view.
- 1.2.1.3 **Long Courses:** in Level III or higher matches must not require more than 32 rounds to complete. At any level match, course design and construction must not require more than 8 scoring hits from any single location or view, nor allow a competitor to shoot all targets in the course of fire from any single location or view.

See the glossary, Appendix A3, for the definition of location and view.

## 1.2.2 Special Courses of Fire:

1.2.2.1 **Standard Exercises** - Courses of fire consisting of two or more separately timed component strings. Scores, with any penalties deducted, are accumulated on completion of the course of fire to produce the final stage results. Standard Exercises must only be scored using Virginia Count or Fixed Time. The course of fire for each component string may require a specific shooting position, procedure and/or one or more mandatory reloads. Standard Exercises must not require more than 24 rounds to complete. Component strings must not require more than 6 rounds (12 rounds if a mandatory reload is specified).

1.2.2.2 **Classifiers** – Courses of fire published by USPSA, which are available to competitors seeking a National classification. Classifiers must be set-up in accordance with these rules and be conducted strictly in accordance with the notes and diagrams accompanying them. Results must be submitted to the publishing entity in the format required (with the applicable fees, if any), in order to be recognized.

1.2.2.3 **Speed Shoot**-Courses of fire consisting of one continuous string of fire not exceeding 16 rounds shot on one or more arrays of multiple targets from a single location or view. The written stage briefing may specify engaging arrays of targets without violating rule (1.1.5), as long as the competitor is allowed to engage said arrays in any order, and individual target engagement is not specified. No more than eight rounds may be required without a mandatory reload and no more than one mandatory reload may be required in the course of fire. Weak/Strong hand may be stipulated after the reload is complete. Stage may be scored either Comstock or Virginia Count. See Rule 9.2.3.2.

1.2.2.3.1 Level II and higher matches are allowed no more than one of these courses of fire per every five stages. The total points available in these courses of fire shall not exceed 20% of the total points available in any match.

## 1.2.3 Supplementary Courses of Fire:

1.2.3.1 **Shoot-Off:** must not require more than nine rounds to complete and must require 1 mandatory reload.

## 1.3 USPSA Sanctioning

1.3.1 Match organizers wishing to receive Level II or Level III USPSA sanction must comply with the general principles of course design and course construction as well as all other current USPSA rules and regulations relevant to the discipline. Courses of fire that do not comply with these requirements will not be sanctioned, and must not be publicized or announced as USPSA sanctioned matches.

- 1.3.2 The Director of NROI, his delegate, or an officer of the Organization (in that order) may withdraw USPSA sanctioning from a match. Such action may be taken at any time where, in his or their opinion, a match contravenes the purpose or spirit of the principles of course design or is in breach of any of the current USPSA Rules or is likely to bring the sport of USPSA shooting into disrepute.
- 1.3.3 USPSA match level requirements and recommendations are specified in Appendix A1.

## **CHAPTER 2: Course Construction and Modification**

The following general regulations of course construction list the criteria, responsibilities and restrictions applicable to courses of fire in USPSA matches. Course designers, host organizations and officials are governed by these regulations.

### **2.1 General Regulations**

- 2.1.1 Physical Construction – Safety considerations in the design, physical construction and stated requirements for any course of fire are the responsibility of the host organization subject to the approval of the Range Master. Reasonable effort must be made to prevent injury to competitors, officials and spectators during the match. Course design should prevent inadvertent unsafe actions wherever possible. Consideration must be given to the operation of any course of fire to provide suitable access for officials supervising the competitors.
- 2.1.2 Safe Angles of Fire – Courses of fire must always be constructed to ensure safe angles of fire. Consideration must be given to safe target and frame construction and the angle of any possible ricochets. Where appropriate the physical dimensions and suitability of backstops and side berms must be determined as part of the construction process.
- 2.1.3 Minimum Distances – Whenever metal targets or metal hard cover are used in a course of fire, precautions must be taken so that competitors and Match Officials maintain a minimum distance of 23 feet from them while they are being shot. Where possible, this should be done with physical barriers. If Fault Lines are used to limit the approach to metal targets, they must be placed at least 26 feet from the targets so that the competitor may inadvertently fault the line and still be outside the 23 feet minimum distance (see Rule 10.5.17). Care should also be taken in respect of metal props in the line of fire.
- 2.1.4 Target Locations – When a course is constructed to include target locations other than immediately downrange, organizers and officials must protect or restrict surrounding areas to which competitors, officials or spectators have access. Each competitor must be allowed to solve the competitive problem in his own way and must not be hindered by being forced to act in any manner which might cause unsafe action. Targets must be arranged so that shooting at them on an “as and when visible”

basis will not cause competitors to breach safe angles of fire.

- 2.1.5 Range Surface – Where possible, the range surface must be prepared prior to the match, and be kept moderately clear of debris during the match, to provide reasonable safety for competitors and officials. Consideration should be given to the possibility of inclement weather and competitor actions. Range Officials may add gravel, sand or other materials to a deteriorated range surface at any time, and such range maintenance actions cannot be appealed by competitors.
- 2.1.6 Obstacles – Natural or created obstacles in a course of fire should reasonably allow for variations in competitors’ height and physical build and should be constructed to provide reasonable safety for all competitors, Match Officials and spectators.
- 2.1.7 Common Firing Lines – Courses of fire where multiple competitors are required to fire simultaneously from a common firing line (e.g. Standard Exercises, Shoot-Off), must provide a minimum of 5 feet of free space between each competitor.
- 2.1.8 Target Placement – Care must be taken with the physical placement of a paper target to prevent a “shoot through”.
  - 2.1.8.1 Target placement should be clearly marked on the target stands for consistent target replacement. Target stands should be securely fixed or their locations should be clearly marked on the range surface.
  - 2.1.8.2 When paper and metal targets are used in close proximity in a course of fire, care must be taken to minimize the risk of splatter from metal targets.
  - 2.1.8.3 When Poppers are used in a course of fire, care should be taken to ensure that the location or foundation area is prepared to provide consistent operation throughout the match.
  - 2.1.8.4 Scoring static Classic paper targets must not be presented at an angle greater than approximately 45 degrees from the vertical. No-shoot static Classic paper targets may be presented at any angle.
  - 2.1.8.5 Appearing scoring targets must be designed and constructed to be obscured to the competitor (during the course of fire) prior to activation.
    - 2.1.8.5.1 Level One matches are encouraged but not required to comply with this requirement. The Written Stage Briefing (WSB) may prohibit competitors from engaging certain targets which may be visible prior to activation until the operation of the activating mechanism has been initiated (see Rule 9.9.4)
- 2.1.9 All berms are off- limits to all persons at all times, except when access to them is specifically permitted by a Range Officer (see Rule 10.6.1).

## **2.2 Course Construction Criteria**

During the construction of a course of fire, a variety of physical barriers may be used to restrict competitor movement and to provide additional competitive challenges as follows:

- 2.2.1 Competitor movement may be restricted or controlled through the use of physical barriers, Fault Lines, Shooting Boxes, or Off-Limits Lines.
  - 2.2.1.1 Shooting Boxes and Fault Lines should be constructed of wooden boards or other suitable material, must be fixed firmly in place, and provide both physical and visual references to competitors. For hard ground surfaces clear of debris, 0.75 inch material is the minimum allowable size. On other range surfaces, such as covered with turf, sand, gravel, wood chips or similar, thicker material which rises at least 1.5 inches above the surface is recommended.
  - 2.2.1.2 Shooting Boxes and Fault Lines are used to define the limits of the shooting area(s). (See Rule 10.2.1)
  - 2.2.1.3 Fault Lines extending rearward (uprange) should be a minimum of 3 feet in length, and unless otherwise stated in the written stage briefing, are deemed to extend rearward to infinity.
  - 2.2.1.4 The use of Shooting Boxes and Fault Lines at prone shooting positions should be avoided or used with caution.
  - 2.2.1.5 Off-Limits Lines may be used to define an area of the range floor which has been declared off-limits. The written stage briefing must identify the presence and location of Off-Limits Lines (if any). The off-limits area must be clearly delineated with rope, caution tape or other materials and must be at least 2 feet high and at least 2 feet from any Fault Line or Shooting Box. (See Rule 10.2.11). Crossing an off-limits line will result in a zero for the stage. Openings in off limits lines are allowed for RO access only; competitors may not use the openings to enter any off limits areas or move through the course of fire in a manner not indicated by the off limits lines. The lines are deemed to extend through the open areas.
- 2.2.2 Obstacles – Courses of fire may include the use of barriers or major obstacles to be surmounted by competitors. Obstacles used in this way must not exceed a height of 6.5 feet. Obstacles over 3 feet in height must be supplied with scaling aids to assist competitors and must be constructed to provide for the competitor's safety in the following ways:
  - 2.2.2.1 Obstacles must be firmly anchored and braced to provide adequate support when in use. Wherever possible, unduly sharp or rough surfaces must be removed to reduce the possibility of injury to competitors and/or Match Officials.

- 2.2.2.2 The descending side of any obstacle must be clear of obstructions or natural hazards.
- 2.2.2.3 Competitors must be allowed to test such obstacles before the course of fire and should be given a short period to do so.
- 2.2.2.4 Competitors must not be required to holster their handgun before ascending these obstacles.
- 2.2.3 Barriers – Must be constructed in the following manner:
  - 2.2.3.1 They must be high enough and strong enough to serve the intended purpose.
  - 2.2.3.2 They should include Fault Lines projecting rearward at ground level from the side edges.
  - 2.2.3.3 Unless otherwise specified in the written stage briefing, all such barriers, walls, vision barriers and snow fence barriers will be considered to go from the ground to the height as constructed.
- 2.2.4 Tunnels – A tunnel that a competitor is required to enter or pass through must be constructed of suitable material and to any length. However, sufficient ports must be provided to allow Match Officials to safely monitor competitor action. Tunnel mouth edges must be prepared to minimize the possibility of injury to competitors and Match Officials. Course designers must clearly designate the entrance and exit portions of the tunnel as well as the parameters for shooting at any targets from within the tunnel (e.g. Fault Lines).
- 2.2.5 “Cooper” Tunnels – Are tunnels comprised of braced uprights supporting loose overhead materials (e.g. wooden slats), which may be inadvertently dislodged by competitors (see Rule 10.2.5). These tunnels may be constructed to any height, but overhead materials must not be heavy enough to cause injury if they fall.
- 2.2.6 Stage Props – Where these items are intended to support a competitor in motion or while shooting targets, they must be constructed with the safety of the competitor and Match Officials as a priority. Provisions must be made to allow Match Officials to safely monitor and control competitor action at all times. Props must be strong enough to withstand use by all competitors.
- 2.3 Modifications to Course Construction**
  - 2.3.1 Match Officials may, for any reason, modify the physical construction or stage procedure for a course of fire, provided that such changes are approved in advance by the Range Master. Any such physical changes or additions to a published course of fire should be completed before the stage begins.
    - 2.3.1.1 In lieu of modifying course design or physical construction, a Range Master may explicitly forbid certain competitor actions in order to maintain safety during a course of fire.



- a. Declaration of a Forbidden Action may be made to prohibit competitor movement which is likely to result in an unsafe condition.
  - b. The declaration of a Forbidden Action cannot be used as a means of compelling or limiting competitor movement within a course of fire (e.g., to prevent a shooter from “cutting the corner” on an L-shaped shooting area). Except as provided in Rule 1.1.5.1, a course designer wishing to compel or limit competitor movement must do so using target placement, vision barriers, physical barriers, or off-limits lines.
  - c. Subject to 2.3.1.1(a) and (b), an area of the range floor may be declared off-limits. The area must be clearly delineated with Off-Limits Lines (Rule 2.2.1.5). Crossing an Off-Limits Line will result in a zero for the stage.
  - d. Any Forbidden Action or Off-Limits Area must be specified in the Written Stage Briefing (See Rules 2.3.3 and 3.2.3).
- 2.3.2 All competitors must be notified of any such changes as soon as possible. At a minimum, they must be notified by the official in charge of the course of fire during the squad briefing.
- 2.3.3 If the Range Master approves any such action after the match begins he must either:
- 2.3.3.1 Allow the course of fire to continue with the modification affecting only those competitors who have not already completed the stage. If a competitor’s actions caused the change, that competitor must be required to reshoot the altered course of fire; or
  - 2.3.3.2 If possible, require all competitors to complete the course of fire as revised with all previous attempts removed from the match scores.
  - 2.3.3.3 A competitor who refuses to reshoot a course of fire, under this or any other section, when so ordered by a Range Official, will receive a zero score for that stage, irrespective of any previous attempt.
- 2.3.4 If the Range Master (in consultation with the Match Director) determines that the physical or procedural change results in a loss of competitive equity and it is impossible for all competitors to attempt the revised stage, or if the stage has been rendered unsuitable or unworkable for any reason, that stage and all associated competitor scores must be deleted from the match.
- 2.3.5 During inclement weather, the Range Master may order that paper targets be fitted with transparent protective covers and/or overhead shelters, and this order is not subject to appeal by competitors (see Rule 6.5.1). Such items must be applied and remain fitted to all affected

targets for the same period of time, until the order is rescinded by the Range Master.

- 2.3.6 If the Range Master (in consultation with the Match Director) deems that climatic or other conditions have, or are likely to, seriously affect the safety and/or conduct of a match, he may order that all shooting activities be suspended, until he issues a “resume shooting” directive.

## **2.4 Safety Areas**

The host organization is responsible for the construction and placement of a sufficient number of Safety Areas for the match. They should be conveniently placed and easily identified with signs. At level II or higher matches, Safety Areas must include a table with the safe direction and boundaries clearly shown.

- 2.4.1 Competitors are permitted to use the Safety Areas for the activities stated below provided they remain within the boundaries of the Safety Area and the firearm is pointed in a safe direction. Violations are subject to match disqualification (see Rules 10.5.1 & 10.5.12).

2.4.1.1 Casing, uncasing, and holstering unloaded firearms.

2.4.1.2 Practice the mounting, drawing, “dry-firing” and re-holstering of unloaded firearms.

2.4.1.3 Practice the insertion and removal of empty magazines and/or to cycle the action of a firearm.

2.4.1.4 Conduct inspections, stripping, cleaning, repairs and maintenance of firearms, component parts and other accessories.

- 2.4.2 Dummy ammunition (including practice or training rounds, snap caps and empty cases), loaded magazines, loaded speed loading devices and live rounds must not be handled in a Safety Area under any circumstances (see Rule 10.5.12).

## **2.5 Unloading/Loading Station**

- 2.5.1 If it is possible that some competitors arriving at a range where a USPSA match is being held may be in possession of a loaded firearm on their person (e.g. law enforcement officers, persons duly authorized to carry a loaded firearm, etc.), match organizers should provide an Unloading/Loading Station to enable such competitors to safely unload their firearms prior to entering the range, and to safely load their firearms again on departure from the range. The Unloading/Loading Station should be conveniently located outside the entrance to the range (or outside the portion of the range allocated to the USPSA match), it should be clearly sign-marked and it must include a suitable impact zone.

2.5.2 Where no Unloading/Loading station is provided, a competitor who arrives at a match in possession of a loaded firearm and proceeds immediately to a match official for the express purpose of safely unloading the firearm shall not be subject to disqualification per the provisions of Rule 10.5.13.

## **CHAPTER 3: Course Information**

### **3.1 General Regulations**

The competitor is always responsible to safely fulfill the requirements of a course of fire but can only reasonably be expected to do so after verbally or physically receiving the written stage briefing, which must adequately explain the requirements to the competitors. Course information can be broadly divided into the following types:

- 3.1.1 Published Courses of Fire – Registered competitors must be provided with the same course of fire information, within the same notice period, in advance of the match. The information may be provided by physical or electronic means, or by reference to a website (also see Section 2.3).
- 3.1.2 Non-Published Course of Fire – Same as Rule 3.1.1 except that the details for the course of fire are not published beforehand. The stage instructions are provided in the written stage briefing.

### **3.2 Written Stage Briefings:**

3.2.1 A written stage briefing approved by the Range Master must be posted at each course of fire prior to commencement of the match. This briefing will take precedence over any course of fire information published or otherwise communicated to competitors in advance of the match, and it must provide the following minimum information:

- Scoring Method:
- Targets (type & number):
- Minimum number of rounds:
- The handgun ready condition:
- Start position:
- Time starts: audible or visual signal:
- Procedure:

3.2.2 The Range Official in charge of a course of fire must read out the written stage briefing verbatim to each squad.

3.2.3 The Range Master may modify a written stage briefing at any time for reasons of clarity, consistency or safety (see Section 2.3).

3.2.4 After the written stage briefing has been read to competitors, and any questions about the course of fire have been answered, competitors should be permitted to conduct an orderly inspection (“walkthrough”) of the course of fire. The duration of time for the inspection must be stipulated by the Range Officer, and it should be the same for all competitors. If the course of fire includes moving targets or similar items, these should be demonstrated to all competitors for the same duration and frequency.

3.2.5 A written stage briefing must comply with the current USPSA rules.

- 3.2.6 In the event that a competitor action contravenes the course requirements, and that action creates a safety issue, the Range Master must be immediately summoned for a ruling. The Range Master may rule that the action is allowed and the competitor's score will stand. Alternatively, the Range Master may require modifications to the course of fire, and/or may declare that the action is "forbidden" for safety reasons. (See Rule 2.3, including subsections)
- 3.2.6.1 Following the declaration of a Forbidden Action, the shooter(s) whose action(s) resulted in such a declaration shall be required to reshoot the course of fire. Subsequent violations by any competitor will result in a disqualification.

### **3.3 Applicability of Rules:**

USPSA matches are governed by the rules applicable to the discipline. Host organizations may not enforce local rules except to comply with legislation or legal precedent in the applicable jurisdiction. Any voluntarily adopted rules that are not in compliance with these rules must not be applied to USPSA matches without the express written consent of the President of USPSA. All local rules allowed under these provisions will be documented at USPSA HQ.

- 3.3.1 In states where competitors are restricted by law to maximum magazine capacity, that maximum capacity will be the maximum allowed for all competitors in the contest. Any such limitations must be made known to all competitors by the Match Director/Range Master before the start of the match.

## **CHAPTER 4: Range Equipment**

### **4.1 Targets – General Principles**

- 4.1.1 Only targets listed in Appendix B are to be used for USPSA Handgun matches.
- 4.1.2 Scoring targets used in all USPSA Handgun matches must be of a single color, as follows:
- 4.1.2.1 The scoring area of scoring paper targets must be of a typical cardboard color.
- 4.1.2.2 The entire front of scoring metal targets must be painted a single color, preferably white. Scoring metal targets may not be painted black, red or green.
- 4.1.3 No-shoots must be clearly marked or be of a single color different from scoring targets. Metal no-shoots in the general size and shape of authorized paper targets may be used. Metal no-shoots do not have a non-scoring border. No-shoots may not have holes cut in them and be used as penalty targets that must be shot through to hit a scoring target; see 9.1.5.
- 4.1.4 Targets used in a course of fire may be partially or wholly hidden through the use of hard or soft cover:

- 4.1.4.1 Cover provided to hide all or a portion of a target will be considered hard cover. When possible hard cover should not be simulated but constructed using impenetrable materials (see Rule 2.1.3). Whole paper targets must not be used solely as hard cover.
- 4.1.4.2 Cover provided merely to obscure targets is considered soft cover. Shots which have passed through soft cover and which strike a scoring target will score. Shots that have passed through soft cover before hitting a no-shoot will be penalized. All scoring zones on targets hidden by soft cover must be left wholly intact. Targets obscured by soft cover must either be visible through the soft cover or a portion of the affected target(s) must be visible from around or over the soft cover.
- 4.1.5 Declaring a single, intact target to represent two or more targets by use of tape, paint or any other means is prohibited.

## **4.2 Approved Handgun Targets – Paper**

- 4.2.1 There are two types of paper targets approved for use in USPSA Handgun matches (see Appendix B). These types must not be included together in any stage. This includes using one type as scoring and the other as a no-shoot.
- 4.2.2 Paper targets must have scoring lines and non-scoring borders clearly marked on the face of the target, however, scoring lines and non-scoring borders should not be visible beyond a distance of 33 feet. The scoring zones reward power in USPSA matches.
- 4.2.2.1 The face of paper no-shoots must include a sufficiently distinguishable non-scoring border. In the absence of perforations or other suitable markings, the Range Master must order that all affected targets have a replacement non-scoring border drawn or fitted thereon.
- 4.2.3 Paper targets must never be required to receive more than 12 hits before being scored and patched.
- 4.2.4 When the scoring area of a paper target is to be partially hidden, course designers must simulate hard cover in one of the following ways:
  - 4.2.4.1 By actually hiding a portion of the target (see Rule 4.1.4.1).
  - 4.2.4.2 By physically cutting targets to remove the portion deemed to be hidden by hard cover. Such targets must be fitted with a replacement non-scoring border, which must extend the full width of the cut scoring area (see Rule 4.2.2).
  - 4.2.4.3 By painting or taping the portion of the target deemed to be hidden by hard cover a single and visibly contrasting color.
- 4.2.5 Hard Cover (and overlapping no-shoots) must not completely hide the highest scoring zone on a partially hidden paper target. The minimum requirements are specified in Appendix B.

### **4.3 Approved Handgun Targets – Metal**

4.3.1 Approved metal targets for use in USPSA Handgun matches (see Appendix B) are as follows:

4.3.1.1 Poppers (aka Pepper Poppers or Classic Poppers) are approved targets designed to recognize power and must be calibrated as specified in Appendix C.

4.3.1.2 Mini Poppers are approved targets designed to recognize power, are intended to simulate regular sized Poppers placed at greater distances, and must be calibrated as specified in Appendix C.

4.3.1.3 Pepper Poppers and Classic Poppers of all sizes may be included in the same course of fire.

4.3.1.4 Various sizes of metal plates may be used (see Appendix B5), however, metal plates must not be used exclusively in a course of fire. At least one authorized paper target or Popper must be included in each course of fire.

4.3.1.5 Scoring metal targets must be shot and fall or overturn to score. Scoring poppers which fail to fall when hit are subject to the provisions of Appendix C1, 6 & 7. Scoring metal targets which a Range Officer deems to have fallen or overturned due to a shot on the supporting apparatus or prematurely fallen or moved for any reason will be treated as range equipment failure. (See Rule 4.6.1). All Poppers shall follow the guidelines below:

1. That a minimum of 50% of the calibration zone be available at some point in the COF.
2. That the calibration will be done from a point on the COF where the calibration zone is available, closest to where the contested shot was fired.
3. Visible evidence of a hit must be present to calibrate the popper. If no evidence is present, the request for calibration shall be denied.

4.3.1.6 Unlike Poppers, metal plates are not subject to calibration or calibration challenges. If a scoring metal plate has been hit but fails to fall or overturn, the Range Officer shall declare range equipment failure and order the competitor to reshoot the course of fire, after the faulty plate has been rectified.

4.3.1.6.1 A plate that has been hit multiple times and falls or overturns before a Range Officer can stop the competitor, will be scored as hit and there will be no reshoot issued.

4.3.1.7 Metal scoring targets must, if hit, be painted after each competitor. An inadvertent failure to paint one or more targets prior to a competitor's attempt at the course of fire shall not be grounds for a reshoot.

4.3.1.7.1 Level 1 matches are encouraged to paint after each competitor but are not required to do so. Poppers that are not repainted between shooters can be challenged for calibration, unless the RO determines that the popper was not hit.

4.3.1.8 Metal no-shoot targets which are designed to fall when hit, but which fail to fall or overturn when struck by a full or partial diameter hit, shall incur the penalty or penalties in accordance with Rule 9.4.3. Failure to fall is not grounds for a reshoot per range equipment failure.

4.3.1.9 Metal no-shoots targets must, if hit, be repainted after each competitor ends their attempt at the course of fire, failing which subsequent competitors must not be penalized for hits visible on their surface.

#### **4.4 Frangible and Synthetic Targets**

4.4.1 Frangible targets, such as clay pigeons or tiles, are not authorized targets for USPSA Handgun matches.

4.4.2 Synthetic targets (e.g. “self-sealing” targets etc.), sometimes used by indoor ranges, may be used at Level I matches provided they comply with the sizes specified in Appendix B5.

#### **4.5 Rearrangement of Range Equipment or Surface**

4.5.1 The competitor must not interfere with the range surface, natural foliage, constructions, props or other range equipment (including targets, target stands and target activators) at any time. Violations may incur one procedural penalty per occurrence at the discretion of the Range Officer.

4.5.1.1 Exception - a competitor is allowed to move stone, sand or other loose material at the starting position for the purposes of achieving level and stable footing.

4.5.2 The competitor may request that Match Officials take corrective actions to ensure consistency in respect of the range surface, the

presentation of targets and/or any other matter. The Range Master will have final authority concerning all such requests.

#### **4.6 Range Equipment Failure and Other Issues**

- 4.6.1 Range equipment must present the challenge fairly and equitably to all competitors. Range equipment failure includes, the displacement of paper targets, the premature activation of metal or moving targets, the failure to reset moving targets or steel targets, the malfunction of mechanically or electrically operated equipment, and the failure of props such as openings, ports, and barriers.
  - 4.6.1.1 The declaration and/or use of any loaded (see Appendix A3) or unloaded firearm as “range equipment” is prohibited.
- 4.6.2 A competitor who is unable to complete a course of fire due to range equipment failure, or if a metal or moving target was not reset prior to his attempt at a course of fire, must be required to reshoot the course of fire after corrective actions have been taken.
- 4.6.3 Chronic malfunction of equipment in a course of fire may result in the removal of that stage from the match results (see Rule 2.3.4).

## **CHAPTER 5: Competitor Equipment**

### **5.1 Handguns**

- 5.1.1 Handguns are separated and defined by Divisions (see Appendix D) however, courses of fire must remain consistent for all Divisions.
- 5.1.2 The minimum cartridge case dimension for handguns to be used in USPSA matches is 9x19 mm. The minimum bullet diameter is 9 mm (.354 inches).
- 5.1.3 Sights – Types of sights identified by USPSA are:
  - 5.1.3.1 “Open sights” - aiming devices fitted to a handgun which do not use electronic circuitry and/or lenses.
  - 5.1.3.2 “Optical/electronic sights” - aiming devices fitted to a handgun which use electronic circuitry and/or lenses.
  - 5.1.3.3 The Range Master is the final authority in respect of the classification of any sights used in an USPSA match and/or their compliance with these rules, including the Divisions in Appendix D.
- 5.1.4 Unless required by a Division (see Appendix D), there is no restriction on the trigger pull weight of a handgun, however, the trigger mechanism must, at all times, function safely.
- 5.1.5 Triggers and/or trigger shoes that extend beyond the width of the trigger guard are expressly prohibited.
- 5.1.6 Handguns must be serviceable and safe. Range Officers may demand examination of a competitor’s handgun or related equipment, at any time,



to check they are functioning safely. If any such item is declared unserviceable or unsafe by a Range Officer, it must be withdrawn from the match until the item is repaired to the satisfaction of the Range Master.

- 5.1.7 Competitors must use the same handgun and type of sights for all courses of fire in a match. However, in the event that a competitor's original handgun and/or sights become unserviceable or unsafe during a match, the competitor must, before using a substitute handgun and/or sights, seek permission from the Range Master who may approve the substitution provided he is satisfied:
  - 5.1.7.1 The substitute handgun satisfies the requirements of the relevant Division.
  - 5.1.7.2 In using the substitute handgun the competitor will not gain a competitive advantage.
  - 5.1.7.3 The competitor's replacement handgun and its appropriate ammunition must be chronographed per Rule 5.6, regardless of whether or not the original handgun was previously tested.
  - 5.1.7.4 If the original handgun/ammunition was not previously tested, and if the original handgun has already been used on a stage, and can be safely fired (i.e. the malfunction is not related to an inability to safely fire the handgun), then the original handgun and its ammunition supply remain subject to testing.
- 5.1.8 A competitor who substitutes or significantly modifies a handgun during a match without the prior approval of the Range Master will be subject to the provisions of Section 10.6.
- 5.1.9 A competitor must never use or wear more than one handgun during a course of fire (see Rule 10.5.7).
- 5.1.10 Handguns with shoulder stocks and/or fore grips of any kind are prohibited.
- 5.1.11 Handguns offering "burst" and/or fully automatic operation are prohibited.
- 5.2 Holsters and Other Competitor Equipment**
  - 5.2.1 Carry and Storage – Except when within the boundaries of a safety area, or when under the supervision and direct command of a Range Officer, competitors must carry their handguns unloaded in a gun case, gun bag or in a holster securely attached to a belt on their person (see Rule 10.5.1). A competitor who, while not at a safety area or under RO supervision, removes their holster or their equipment belt with their handgun still in the holster, shall be considered to be in violation of Rule 5.2.1 and subject to disqualification from the match.
  - 5.2.2 Competitors carrying their handgun in a holster must have an empty magazine well, and the hammer or striker must be de-cocked. Anyone found in violation of this rule will be immediately escorted by a Range Officer to a suitable range or safety area where appropriate corrective action shall be made.

- 5.2.3 Unless specified in the written stage briefing, the belt carrying the holster and allied equipment must be worn during the course of fire; the belt must be worn at the waist level, which is deemed to be at the same level as the original belt loops on the lower garment. (See 5.2.3.1 for exceptions.) The belt or the inner belt or both must be either securely fixed at the waist, or secured with a minimum of three belt loops. The belt may be removed between courses of fire.
- 5.2.3.1 Lady competitors are permitted to wear a belt, holster and allied equipment at hip level, however, the top of the belt must not be positioned below the furthest lateral point of the top of the femur (tuberosity major).
- 5.2.4 During the course of fire, after the start signal, unless stipulated otherwise in the stage procedure, spare ammunition, magazines and/or speed loading devices shall be carried in retention devices attached to the competitor's belt and specifically designed for that purpose. Unless specifically prohibited in the Written Stage Briefing, a competitor may also carry additional magazines or speed loading devices in apparel pocket(s) and retrieve and use them, providing that the location of the apparel pocket does not violate the requirements of Appendix D, Item 12 (subject to the provisions of Rule 6.2.5.1).

Should the division restrict the location of the magazines or speed loading devices, carrying them in apparel pocket(s) forward of the restriction point will be allowed providing they are not removed from the apparel pocket(s) between the “standby” command and the command “if clear, hammer down and holster”. (*e.g. – a magazine may be retrieved from a front pocket to facilitate loading before the start signal or while unloading at the end of a COF without penalty*). When stipulations in the WSB require placement of magazines or speed loaders on a table or similar location and not in the retention devices prior to the start signal, retrieving them and using them from the hand is allowed. Further, spare ammunition, magazines and/or speed loading devices carried in the hand after the start signal are not subject to the equipment position restrictions of Appendix D, Item 12, as long as they remain in the hand.

- 5.2.5 Where a Division specifies a maximum distance that a competitor's handgun and equipment may extend away from a competitor's belt, the measurement shall be taken in the following manner:
- Perpendicular to the belt at the point of attachment to the belt
  - from the inner most surface of the belt equipment (against the pants/body) to the closest point of the grip of the handgun and/or any reloading device.
- 5.2.5.1 These measurements may be taken with the equipment as worn or removed (see App. E2).
- 5.2.5.2 Any competitor who fails the foregoing test will be required to

immediately adjust his holster or equipment to comply with the requirements of the relevant Division. The Range Master may make allowances for variations in these requirements due to anatomical considerations. Some competitors may not be able to fully comply.

- 5.2.5.3 Unless specified in the written stage briefing, or unless required by a Range Officer, the position of holsters and allied equipment on the belt must not be moved or changed by a competitor during a match. If a retaining strap is attached to a holster or magazine pouch, it must be applied or closed prior to issuance of the “Standby” command.
- 5.2.6 USPSA Handgun matches will not require the use of a particular type or brand of holster. However, the Range Master may deem that a competitor’s holster is unsafe and order that it be improved to his satisfaction, failing which it must be withdrawn from the match. Divisions may restrict a specific type of holster.
- 5.2.7 Competitors must not be permitted to commence a course of fire wearing:
  - 5.2.7.1 A shoulder holster or “tie-down” rig (visible or otherwise), except as specified in Rule 5.2.8.
  - 5.2.7.2 A holster with the heel of the butt of the handgun below the top of the belt, except as specified in Appendix D, or otherwise indicated in Rule 5.2.8.
  - 5.2.7.3 A holster with the muzzle of the handgun pointing further than 3 feet from the competitor’s feet while standing relaxed,
  - 5.2.7.4 A holster which does not completely prevent access to, or activation of, the trigger while holstered.
- 5.2.8 Competitors deemed by the Match Director to be full-time law enforcement officers with arrest powers or military personnel on current active duty orders, may be entitled to use their duty holsters or similar holster and related equipment when such equipment does not strictly satisfy the equipment or other requirements of the declared Division. The Range Master will remain the final authority in respect of the safety and suitability of using such equipment at USPSA matches. The use of such equipment, except as otherwise permitted in the rules, is restricted to Level I matches only.
- 5.2.9 Competitors deemed by the Range Master to be significantly disabled may be given special dispensation in relation to the type and/or placement of their holster and related equipment, and the Range Master will remain the final authority in respect of the safety and suitability of using such equipment at USPSA matches.

### **5.3 Appropriate Dress**

- 5.3.1 The use of offensive or objectionable garments is not allowed. The Match Director will have final authority in respect of what garments competitors are allowed to wear.

### **5.4 Eye and Hearing Protection**

- 5.4.1 All persons on the range potentially exposed to ricochet debris or bullet fragments are required to wear eye protection. All persons on the range where the sound of firearms being fired may potentially cause hearing damage are required to wear adequate hearing protection.
- 5.4.2 If a Range Officer deems that a competitor about to make an attempt at a course of fire is wearing inadequate eye or hearing protection, the Range Officer may order the competitor to rectify the situation before allowing the competitor to continue. The Range Master is the final authority on this matter.
- 5.4.3 If a Range Official notices that a competitor has lost or displaced their eye or hearing protection during a course of fire, or has commenced a course of fire without either one, the Range Official must immediately stop the competitor who will be required to reshoot the course of fire after the protective devices have been restored.
- 5.4.4 A competitor who inadvertently loses eye or hearing protection during a course of fire, or commences a course of fire without either one, is entitled to stop, point their handgun in a safe direction and indicate the problem to the Range Official, in which case the provisions of the previous rule will apply.
- 5.4.5 A competitor who intentionally loses or displaces eye and/or hearing protection during a course of fire will be disallowed the provisions of Rule 5.4.4, and will be subject to match disqualification (see Rule 10.6.3)

### **5.5 Ammunition and Related Equipment**

- 5.5.1 Magazines and speed loading devices must comply with the provisions of the relevant Division.
- 5.5.2 Spare magazines, speed loading devices or ammunition dropped or discarded by a competitor after the start signal may be retrieved, however, their retrieval is, at all times, subject to all safety rules.
- 5.5.3 Metal piercing, incendiary and/or tracer ammunition is prohibited at USPSA matches (see Rule 10.5.15).
- 5.5.4 All ammunition used by a competitor must satisfy the requirements of the relevant Division. (Appendix D)
- 5.5.5 Any ammunition deemed unsafe by a Range Officer must be immediately withdrawn from the match.
- 5.5.6 Ammunition must not discharge more than one bullet or other scoring projectile from a single round.

## **5.6 Chronograph and Power Factors**

- 5.6.1 One or more official match chronographs are used to assist in the determination of the power factor of every competitor's ammunition. In the absence of official match chronograph(s), the power factor declared by a competitor cannot be challenged.
  - 5.6.1.1 The power factor rating to enable a competitor's scores to be included in match results is called "Minor". Some Divisions offer a higher power factor rating called "Major", which enables competitors to earn more points for peripheral shots on scoring paper targets.
  - 5.6.1.2 The power factor floor for Minor rating and the power factor floor for Major rating, if available, and other specific requirements applicable to each Division are stipulated in Appendix D.
  - 5.6.1.3 The associated values awarded for Minor and Major scoring hits are illustrated in Appendix B.
  - 5.6.1.4 The method used to determine power factor and the procedures used at the Chronograph Station are stipulated in Appendix C2.

## **5.7 Malfunctions – Competitor's Equipment**

- 5.7.1 A competitor who experiences a handgun malfunction while responding to the "Make Ready" command, but prior to issuance of the "Start Signal", is entitled to retire to repair his handgun without penalty, under the authority and supervision of the officiating Range Officer and subject to the provisions of Rule 5.7.5, Rule 8.3.1.1, and all other safety rules. Once the repairs have been completed (and the provisions of Rule 5.1.7 have been satisfied, if applicable), the competitor may return to attempt the course of fire, subject to scheduling as determined by the officiating Range Officer or Range Master.
- 5.7.2 In the event that a competitor's handgun malfunctions after the Start signal, the competitor may safely attempt to correct the problem and continue the course of fire. During such corrective action, the competitor must keep the muzzle of the handgun pointing safely downrange at all times.
- 5.7.3 While rectifying a malfunction that requires the competitor to clearly move the handgun away from aiming at a target, the competitor's fingers must be clearly outside the trigger guard (see Rule 10.5.8).
- 5.7.4 In the event that a handgun malfunction cannot be corrected by the competitor within 2 minutes, he must point the handgun safely downrange and advise the Range Officer, who will terminate the course of fire (excluding any unattempted component strings in a Standard Exercise) in the normal manner. The course of fire (excluding any unattempted component strings in a Standard Exercise) will be scored as shot including all applicable misses and penalties.

- 5.7.5 Under no circumstances is a competitor permitted to leave a course of fire in the possession of a loaded handgun (see Rule 10.5.13).
- 5.7.6 Where the handgun has failed after the Start signal, the competitor must not be permitted to reshoot the course of fire or string. This includes the instance where a handgun is declared unserviceable or unsafe during a course of fire or string. However, any unattempted component strings in a Standard Exercise may still be attempted by the affected competitor after the handgun has been repaired, and prior to when match results are declared final by the Match Director.
- 5.7.7 In the event that a Range Officer terminates a course of fire due to a suspicion that a competitor has an unsafe handgun or unsafe ammunition (e.g. a “squib” load), the Range Officer will take whatever steps he deems necessary to return both the competitor and the range to a safe condition. The Range Officer will then inspect the handgun or ammunition and proceed as follows:
- 5.7.7.1 If the Range Officer finds evidence that confirms the suspected problem, the competitor will not be entitled to a reshoot, but will be ordered to rectify the problem. On the competitor’s score sheet, the time will be recorded up to the last shot fired, and the course of fire will be scored “as shot”, including all applicable misses and penalties.
- 5.7.7.2 If the Range Officer discovers that the suspected safety problem does not exist, the competitor will be required to reshoot the stage.

## **5.8 Official Match Ammunition**

- 5.8.1 See Appendix C3
- 5.8.1.1 The competitor must obtain, and retain for the duration of the match, an official receipt from the match organizers (or their nominated vendor) at the match evidencing details of the quantity and description of the subject ammunition purchased at the match, and said receipt must be produced on demand by any Match Official, failing which the provisions of Rule 5.8.1 will not apply. Ammunition not purchased from the match organizers (or their nominated vendor) at the match will not enjoy the provisions of Rule 5.8.1, regardless of whether or not such ammunition appears, for all intents and purposes, to be identical to official match ammunition.
- 5.8.1.2 Official match ammunition purchased by competitors is deemed to be competitor equipment (see Section 5.7). Malfunctions will not be grounds for a reshoot and/or an appeal to Arbitration.
- 5.8.1.3 Official match ammunition must be available to every competitor on an equal basis and its accessibility and use may not be restricted only to certain individuals or group.

- 5.8.1.4 Official match ammunition must be approved by the USPSA President.
- 5.8.1.5 Match Officials reserve the right to conduct chronograph or other tests on all and any ammunition, at any time, and a reason need not be given.
- 5.8.2 Where possible, match organizers (or their nominated vendor at the match) should make available a test firing bay, supervised by a Range Officer, where competitors can function test a small quantity of official match ammunition of the same batch through their handgun(s).

## **CHAPTER 6: Match Structure**

### **6.1 General Principles**

The following definitions are used for clarity:

- 6.1.1 String - A separately timed component of a Standard Exercise. Scores and penalties are recorded following completion of the course of fire, unless the course of fire specifies that they shall be recorded and the targets taped between strings. The time component of all strings will be totaled and the results achieved are then tallied to produce a final stage result.
- 6.1.2 Stage – A separately timed and scored component of a match.
- 6.1.3 Match – Consists of a minimum of 2 stages. The total sum of individual stage results will be accumulated to declare a match winner. A match must include only one type of firearm (e.g. handgun, shotgun or rifle).
- 6.1.4 Tournament – Consists of two or more firearm specific matches (e.g. a handgun match and a shotgun match, or a handgun match, a rifle match and a shotgun match), or two or more handgun-type matches (e.g. a 1911 handgun match and a “Brand A” handgun match). The individual match results achieved by a competitor in each component match will be used to declare an overall tournament winner, in accordance with the USPSA Tournament Rules.
- 6.1.5 League – Consists of two or more USPSA matches of a single firearm type held at different locations and on different dates. The total sum of match results attained by each competitor at component matches specified by the league organizers will be accumulated to determine a league winner.
- 6.1.6 Shoot-Off – An event conducted separately from a match. Eligible competitors compete directly against each other by simultaneously shooting at separate but equal target arrays in a process of elimination (Appendix F2 and F3).

## **6.2 Match Divisions**

- 6.2.1 USPSA Divisions recognize different handguns and equipment (see Appendix D). Each match must recognize at least one Division. When multiple Divisions are available in a match, each Division must be scored separately and independently, and match results must recognize a winner in each Division.
- 6.2.2 In USPSA sanctioned matches, the minimum number of competitors stipulated in Appendix A2 must compete in each Division for it to be recognized. If there are insufficient competitors in a Division, the Match Director may allow that Division to stand without official USPSA recognition.
- 6.2.3 Prior to the commencement of a match, each competitor must declare one Division for score. Match Officials should check holsters and other competitor equipment for compliance with the declared Division prior to the competitor making an attempt at any of the courses of fire.
- 6.2.4 Subject to the prior approval of the Match Director, a competitor may enter a match in more than one Division. However, the competitor may compete for match score in only one Division, and that must be the first attempt in all cases. Any subsequent attempts in another Division will not count for match recognition.
  - 6.2.4.1 Level I matches may allow competitors to enter multiple Divisions for match recognition.
- 6.2.5 Where a Division is unavailable or deleted, or where a competitor fails to declare a specific Division prior to the commencement of a match, the competitor will be placed in the Division which, in the opinion of the Range Master, most closely identifies with the competitor's equipment. If, in the opinion of the Range Master, no suitable Division is available, the competitor will shoot the match for no score.
  - 6.2.5.1 However, if a competitor fails to satisfy the equipment or other requirements of a declared Division during a course of fire, the competitor will be placed in Open Division, if available, otherwise the competitor will shoot the match for no score.
  - 6.2.5.2 A competitor who is classified or reclassified as above must be notified as soon as possible. The Range Master's decision on these matters is final.
- 6.2.6 A match disqualification incurred by a competitor, at any time during a match, will prevent the competitor from further participation in the match including any subsequent attempts in another Division. However, this is not retroactive. Any previous and complete match scores from another Division will be included for recognition and awards in that Division.
- 6.2.7 Recognition of a competitor in a specific Division will not preclude further recognition in a Category.



### **6.3 Match Categories**

- 6.3.1 USPSA matches may include different Categories within each Division to recognize different groups of competitors. A competitor may declare multiple Categories for a match or tournament.
- 6.3.2 Failure to meet the requirements of the declared Categories or failure to declare a Category prior to the start of the match will result in exclusion from that Category. Details of currently approved Categories and related requirements are listed in Appendix A2.

### **6.4 Competitor Status and Credentials**

- 6.4.1 All competitors must be individual members of USPSA, or a current member of their IPSC region, for Level II and above competitions. A competitor who submits a paid USPSA membership application to the Match Director or presents proof of online registration and payment as a new member prior to entering the competition is considered a member for the purpose of this rule.
  - 6.4.1.1 Anyone whose membership has been suspended or terminated by USPSA will no longer be eligible to compete in any USPSA match including local (level I) matches. A list of those who are ineligible will be kept at USPSA headquarters for verification.
- 6.4.2 Only current USPSA classifications may be used in determining Class awards.
- 6.4.3 No person may be barred from participating in a USPSA match based on gender, race, religion or occupation.
- 6.4.4 An individual may be barred from participating in a USPSA match, at the match director's discretion, if the person:
  - a. has demonstrated an inability to safely complete courses of fire, or
  - b. has demonstrated behavior which would or may disrupt the match, or which would bring disrepute to the sport.
- 6.4.5 A Match Director enforcing Rule 6.4.4 must submit a detailed report to USPSA within seven days of the occurrence.

### **6.5 Competitor Scheduling and Squadding**

- 6.5.1 Competitors must compete for score according to the published match and squadding schedule. A competitor who is not present at the scheduled time and date for any stage may not attempt that stage without the prior approval of the Match Director or Range Master, failing which the competitor's score for that stage will be zero.
- 6.5.2 Range Officials, match sponsors and other persons may compete for score in a "pre-match", subject to the prior approval of the Match Director. Competitors in the main match must not be restricted from viewing the pre-match. Scores attained in the "pre-match" may, at the discretion of the Match Director, be included in the overall match results provided the dates of the "pre-match" are published in the

official match schedule. (also see Section 2.3).

- 6.5.3 A match, tournament or league will be deemed to have started on the first day that competitors (including those specified above) shoot for score and will be deemed to have ended when the results have been declared final by the Match Director.

## **CHAPTER 7: Match Management**

### **7.1 Match Officials**

The duties and terms of reference of Match Officials are defined as follows:

- 7.1.1 Range Officer (“RO”) – issues range commands, oversees competitor compliance with the written stage briefing and closely monitors safe competitor action. He also declares the time, scores and penalties achieved by each competitor and verifies that these are correctly recorded on the competitor’s score sheet (under the authority of a Chief Range Officer and Range Master).
- 7.1.2 Chief Range Officer (“CRO”) – is the primary authority over all persons and activities in the courses of fire under his control, and oversees the fair, correct and consistent application of these rules (under the authority of the Range Master).
- 7.1.3 Chrono Officer (“CO”) – is the primary authority over all persons and activities at the Chronograph Station, and oversees the fair, correct and consistent application of the pertinent rules and the procedures outlined in Appendix C2 (under direct authority of the Range Master).
- 7.1.4 Stats Officer (“SO”) – collects, sorts, verifies, tabulates and retains all score sheets and ultimately produces provisional and final results (under direct authority of the Range Master). Any incomplete or inaccurate score sheets must be promptly referred to the Range Master.
- 7.1.5 Quartermaster (“QM”) – distributes, repairs and maintains all range equipment and supplies (e.g. targets, patches, paint, props, timers, batteries, staplers, clipboards etc.), (under direct authority of the Range Master).
- 7.1.6 Range Master (“RM”) – has overall authority over all persons and activities within the entire range, including range safety, the operation of all courses of fire and the application of these rules. All match disqualifications and appeals to arbitration must be brought to his attention. The Range Master is usually appointed by and works with the Match Director, however, in respect of USPSA sanctioned Level III and Nationals matches, the appointment of the Range Master is subject to the prior written approval of the Director of NROI.
- 7.1.7 Match Director (“MD”) – handles overall match administration including squadding, scheduling, range construction, the coordination of all support staff and the provision of services. His authority and

decisions will prevail with regard to all matters except in respect of matters in these rules which are the domain of the Range Master. The Match Director is appointed by the host organization and works with the Range Master.

- 7.1.8 Director NROI ("DNROI") - While serving at a match as a member of the staff carries the same overall authority as the Match Director and Range Master. The DNROI while on staff will be there to assist the MD and RM in all endeavors to keep things running smoothly and help to make the match a success.

## **7.2 Discipline of Match Officials**

- 7.2.1 The Range Master has authority over all Match Officials other than the Match Director (except when the Match Director is actually participating as a competitor at the match), and is responsible for decisions in matters concerning conduct and discipline.
- 7.2.2 In the event that a Match Official is disciplined, the Range Master must send a report of the incident and details of the disciplinary action to the Director of NROI.
- 7.2.3 A Match Official who is disqualified from a match for a safety infraction while competing will continue to be eligible to serve as a Match Official for the match. The Range Master will make any decision related to an official's participation.
- 7.2.4 All match officials are subject to the current published Range Officer Discipline Policy, which is posted on the USPSA web site.

## **7.3 Appointment of Officials**

- 7.3.1 Match organizers must, prior to commencement of a match, appoint a Match Director and a Range Master to carry out the duties detailed in these rules. The nominated Range Master should preferably be the most competent and experienced certified Range Official present (see Rule 7.1.6). For Level I and Level II matches a single person may be appointed to be both the Match Director and the Range Master.
- 7.3.2 References in these rules to Range Officials (e.g. "Range Officer", "Range Master" etc.), mean personnel who have been officially appointed by match organizers to actually serve in an official capacity at the match. Persons who are certified Range Officials, but who are actually participating in the match as regular competitors, have no standing or authority as Range Officials for that match. Such persons should therefore not participate in the match wearing garments bearing Range Official insignia.
- 7.3.3 Matches of all Levels shall publicly publish or announce to competitors, the identity of the Match Director, Range Master, Stats Officer or other match officials as appropriate to the level of match.

# CHAPTER 8: The Course of Fire

## 8.1 Handgun Ready Conditions

The ready condition for handguns will normally be as stated below. However, in the event that a competitor fails to load the chamber when permitted by the written stage briefing, whether inadvertently or intentionally, the Range Officer must not take any action, as the competitor is always responsible for the handling of the handgun.

### 8.1.1 Revolvers:

- 8.1.1.1 Single Action: hammer fully down on an empty chamber or, if a safety notch is fitted, hammer down over a loaded chamber (transfer bar designs excepted).
- 8.1.1.2 Double Action: hammer fully down and all chambers may be loaded.
- 8.1.1.3 Non-traditional revolvers (e.g. those which operate in a “self-loading” mode) are not allowed.

### 8.1.2 Self-loading Pistols:

- 8.1.2.1 “Single action” – chamber loaded, hammer cocked, and the safety engaged.
- 8.1.2.2 “Double action” – chamber loaded, hammer fully down or decocked.
- 8.1.2.3 “Selective action” – chamber loaded with hammer fully down, or chamber loaded and hammer cocked with external safety engaged (see Divisions in Appendix D).
- 8.1.2.4 With respect to Rules 8.1.2.1 and 8.1.2.3, the term “safety” means the primary visible safety lever on the handgun (e.g. the thumb safety on a “1911” genre handgun). In the event of doubt, the Range Master is the final authority on this matter. This safety must be on while the firearm is loaded in the holster or loaded in any other location stated in the WSB (e.g.: table start, in a drawer, etc). in order to be in compliance with 10.5.11
- 8.1.2.5 When applicable, the grip safety may be disabled provided that the primary safety as described in 8.1.2.4 is operable. Production division handguns are explicitly excluded from this rule.

- 8.1.3 Courses of fire may require ready conditions which are different to those stated above. In such cases, the required ready condition must be clearly stated in the written stage briefing. When a Handgun Ready Condition requires a handgun be prepared with an empty chamber (or cylinder), the slide of the handgun must be fully forward (or the cylin-

der must be fully closed) and the hammer or striker must be fully down or fully forward, as the case may be, unless otherwise specified in the stage briefing.

8.1.4 Unless complying with a Division requirement (see Appendix D), a competitor must not be restricted on the number of rounds to be loaded or reloaded in a handgun. Written stage briefings may only stipulate when the handgun is to be loaded or when mandatory reloads are required (when permitted under Rules 1.1.5.1 and 1.1.5.2).

8.1.5 In respect of handguns used at USPSA matches, the following definitions apply:

8.1.5.1 “Single Action” means activation of the trigger causes a single action to occur (i.e. the hammer or striker falls).

8.1.5.2 “Double Action” means activation of the trigger causes more than a single action to occur (i.e. the hammer or striker rises or retracts, then falls).

8.1.5.3 “Selective Action” means that the handgun can be operated in either “Single Action” or “Double Action” modes.

## **8.2 Competitor Ready Condition**

This designates when, under the direct command of a Range Officer:

8.2.1 The handgun is prepared as specified in the written stage briefing, and is in compliance with the requirements of the relevant Division.

8.2.2 The competitor assumes the start position as specified in the written stage briefing. Unless otherwise specified, the competitor must stand erect, facing downrange, with arms and hands hanging naturally by the sides (see appendix E3 for an example of this). A competitor who attempts or completes a course of fire where an incorrect start position was used must be required by a Range Official to reshoot the course of fire. “Arms hanging naturally by sides” is illustrated in Appendix E3.

8.2.3 A course of fire must never require or allow a competitor to touch or hold a handgun, loading device or ammunition after the “Standby” command and before the “Start Signal” (except for unavoidable touching with the lower arms).

8.2.4 A course of fire must never require the competitor to draw a handgun from the holster with the weak hand.

8.2.5 A course of fire must never require the competitor to re-holster a handgun after the start signal. However, a competitor may re-holster provided this is accomplished safely, and the handgun is either unloaded or in a ready condition stated in Section 8.1.

## **8.3 Range Communication**

The approved range commands and their sequence are as follows:

8.3.1 “**Make Ready**” – This command signifies the start of “the Course of Fire”. Under the direct supervision of the Range Officer the competitor must face down range, or in a safe direction as specified by the Range

Officer, fit eye and hearing protection, and prepare the handgun in accordance with the written stage briefing. The competitor must then assume the specified start position. The Range Officer will not proceed with any further range commands until the competitor is still and is in the correct start position.

- 8.3.1.1 Once the “Make Ready” command has been given, the competitor must not move away from the start location prior to issuance of the “Start Signal” without the prior approval, and under the direct supervision, of the Range Officer.
- 8.3.2 **“Are You Ready?”** – The lack of any negative response from the competitor indicates that he fully understands the requirements of the course of fire and is ready to proceed. If the competitor is not ready at the “Are You Ready?” command, he must indicate to the Range Officer that he is not ready.
- 8.3.3 **“Standby”** – This command should be followed by the start signal within 1 to 4 seconds.
- 8.3.4 **“Start Signal”** – The signal for the competitor to begin their attempt at the course of fire. If a competitor fails to react to a start signal, for any reason, the Range Officer will confirm that the competitor is ready to attempt the course of fire, and will resume the range commands from “Are You Ready?”.
  - 8.3.4.1 In the event that a competitor begins his attempt at the course of fire prematurely (“false start” prior to the issuance of the start signal) the Range Officer will, as soon as possible, stop and restart the competitor once the course of fire has been restored.
- 8.3.5 **“Stop”** – Any Range Officer assigned to a stage may issue this command at any time during the course of fire. The competitor must immediately cease firing, stop moving and wait for further instructions from the Range Officer.
- 8.3.6 **“If You Are Finished, Unload And Show Clear”** or **“Unload and Show Clear”** – If the competitor has finished shooting, he must lower his handgun and present it for inspection by the Range Officer with the muzzle pointed down range, magazine removed, slide locked or held open, and chamber empty. Revolvers must be presented with the cylinder swung out and empty.

If a competitor has been stopped by the Range Officer, they will be given “Unload and show clear” as the command.

- 8.3.6.1 When conducting Standard Exercises, Range Officials may issue other interim commands on completion of the first string, in order to prepare the competitor for the second and subsequent strings. (e.g. “Reload if required and holster”). This option may also be applied when two or more courses of fire share a common shooting bay or area.

- 8.3.7 **“If Clear, Hammer Down, Holster”** or **“If Clear, Cylinder Closed, Holster”** for revolvers only – After issuance of this command, the competitor is prohibited from firing (see Rule 10.4.3). While continuing to point the handgun safely downrange, the competitor must perform a final safety check of the handgun as follows:
- 8.3.7.1 Self-loaders – release the slide and pull the trigger (without touching the hammer or decocker, if any).
  - 8.3.7.2 Revolvers – close the empty cylinder (without touching the hammer, if any).
  - 8.3.7.3 If the gun proves to be clear, the competitor must holster his handgun.
  - 8.3.7.4 If the gun does not prove to be clear, the Range Officer will resume the commands from Rule 8.3.6 (also see Rule 10.4.3).
- 8.3.8 **“Range Is Clear”** – This declaration signifies the end of the Course of fire. Once the declaration is made, officials and competitors may move forward to score, patch, reset targets etc.

#### **8.4 Loading, Reloading or Unloading During a Course of Fire**

- 8.4.1 When loading, reloading or unloading during a course of fire, the competitor’s fingers must be visibly outside the trigger guard and the handgun must be pointed safely down range or in another safe direction authorized by a Range Officer (see Section 10.5).

#### **8.5 Movement**

- 8.5.1 Except when the competitor is actually aiming or shooting at targets, all movement (see Appendix A3) must be accomplished with the fingers visibly outside the trigger guard and the safety should be engaged. The handgun must be pointed in a safe direction.
- 8.5.2 If a competitor holsters a loaded handgun at any time during a course of fire, it must be placed in the applicable handgun ready conditions (see Section 8.1). Violations will be subject to match disqualification (see Rule 10.5.11).
- 8.5.2.1 For a single action self-loader the safety must be applied.
  - 8.5.2.2 For double action self-loaders and revolvers the hammer must be down.

#### **8.6 Assistance or Interference**

- 8.6.1 No assistance of any kind can be given to a competitor during a course of fire, except that any Range Officer assigned to a stage may issue safety warnings to a competitor at any time. Such warnings will not be grounds for the competitor to be awarded a reshoot.
- 8.6.2 Any person providing interference or unauthorized assistance to a competitor during a course of fire (and the competitor receiving such assistance) may, at the discretion of a Range Officer, incur a

procedural penalty for that stage and/or be subject to Section 10.6.

- 8.6.2.1 When approved by the Range Officer, competitors at Level I matches may, without penalty, receive whatever coaching or assistance they request.
- 8.6.3 Competitors confined to wheelchairs or similar devices may be given special dispensation by the Range Master in respect of mobility assistance, however, the provisions of Rule 10.2.10 may still apply, at the Range Master's discretion.
- 8.6.4 In the event that inadvertent contact from the Range Officer or another external influence has interfered with the competitor during a course of fire, the Range Officer may offer the competitor a reshoot of the course of fire. The competitor must accept or decline the offer prior to seeing either the time or the score from the initial attempt. However, in the event that the competitor commits a safety infraction during any such interference, the provisions of Section 10.3 may still apply.

## **8.7 Sight Pictures and Range Inspection**

- 8.7.1 A competitor is permitted to take a sight picture prior to the start signal. Such sight picture is only permitted no more than one step from the "Make Ready" location.
- 8.7.2 Competitors are prohibited from using any guns or gun replicas as sighting aids while conducting their inspection ("walkthrough") of a course of fire. Violations will incur one procedural penalty per occurrence (also see Rule 10.5.1).
- 8.7.3 No person is permitted to enter or move through a course of fire without the prior approval of a Range Officer assigned to that course of fire or the Range Master.
- 8.7.4 Altering stage props, targets or any other part of a COF without the approval of a Range Officer, or setting, resetting or activating moving targets on a COF identified as "Closed" or "Off Limits" will be subject to the provisions of Section 10.6. Any person interfering with the scoring or resetting of a course of fire in any way may be assessed a procedural penalty or be subject to the provisions of 10.6. The Range Master shall be called in all cases, and will make the decision as to what penalty to assess.

# **CHAPTER 9: Scoring**

## **9.1 General Regulations**

- 9.1.1 Approaching Targets – While scoring is in progress, competitors or their delegate must not approach any target closer than (3 feet) without the authorization of the Range Officer. Violation may, at the discretion of the Range Officer, incur a procedural penalty.



- 9.1.2 Touching Targets – While scoring is in progress competitors or their delegate must not touch, gauge or otherwise interfere with any target without the authorization of the Range Officer. Should a Range Officer deem that a competitor or their delegate has influenced or affected the scoring process due to such interference, the Range Officer may:
  - 9.1.2.1 Score the affected target as a missed target; or
  - 9.1.2.2 Impose penalties for any affected no-shoots.
- 9.1.3 Prematurely Patched Targets - If a target is prematurely patched or taped, which prevents a Range Official from determining the actual score, the Range Officer must order the competitor to reshoot the course of fire. However, if following the scoring of a target by any assigned Range Officer, the target is patched or taped by anyone other than a Range Officer, the score will stand as called regardless of the competitor's opportunity to see the target in question and the competitor will not be permitted to appeal the score as called. Reviewing previous score sheets is prohibited; targets must be scored as is, using the actual target as the basis for the scoring call.
- 9.1.4 Unrestored Targets – If, following completion of a course of fire by a previous competitor, one or more targets have not been properly patched or taped or if previously applied pasters have fallen off the target for the competitor being scored, the Range Officer must judge whether or not an accurate score can be determined. If there are extra scoring hits or questionable penalty hits thereon, and it is not obvious which hits were made by the competitor being scored, the affected competitor must be ordered to reshoot the course of fire. For the purpose of this rule, B-zone and C-zone hits shall be considered one and the same. Reviewing previous score sheets is prohibited; targets must be scored as is, using the actual target as the basis for the scoring call.
- 9.1.5 Impenetrable – The scoring area of USPSA scoring targets and no-shoots is deemed to be impenetrable:
  - 9.1.5.1 If a bullet strikes wholly within the scoring area of a paper target, and continues on to strike the scoring area of another paper target, the hit on the subsequent paper target will not count for score or penalty, as the case may be.
    - 9.1.5.1.1 In accordance with Rule 9.1.5, the scoring areas of scoring targets and no-shoots are impenetrable. Whenever two targets (scoring and/or no-shoots) are in direct contact where one target directly overlaps part of another target, the area of the "under" target which is directly covered by the scoring area of the "over" target and its perforations is deemed to be non-existent.

Additionally, Rule 9.5.2 is clarified to apply only to the visible portions of targets. It specifically does not apply to any area of any target which is in direct contact with and overlapped by the scoring area of another target (scoring and/or no-shoots) or by hardcover. See illustration in Appendix.

- 9.1.5.2 If a bullet strikes wholly within the scoring area of a paper target, and continues on to hit a plate or strike down a popper; this will be treated as range equipment failure. The competitor will be required to reshoot the course of fire, after it has been restored
- 9.1.5.3 If a bullet strikes partially within the scoring area of a paper or metal target, and continues on to strike the scoring area of another paper target, the hit on the subsequent paper target will also count for score or penalty, as the case may be.
- 9.1.5.4 If a bullet strikes partially within the scoring area of a paper or metal target, and continues on to strike down or hit the scoring area of another metal target, the subsequent metal target will also count for score or penalty, as the case may be.
- 9.1.6 Unless specifically described as “soft cover” (see Rule 4.1.4.2) in the written stage briefing, all props, walls, barriers, vision screens and other obstacles are deemed to be impenetrable “hard cover”:
  - 9.1.6.1 If a bullet strikes wholly within hard cover, and continues on to strike any scoring paper target or no-shoot, that shot will not count for score or penalty, as the case may be.
  - 9.1.6.2 If a bullet strikes wholly within hard cover, and continues on to hit a plate or strike down a popper; this will be treated as range equipment failure (see Section.4.6). The competitor will be required to reshoot the course of fire, after it has been restored.
  - 9.1.6.3 If a bullet strikes partially within hard cover, and continues on to strike the scoring area of a paper target, the hit on that paper target will count for score or penalty, as the case may be.
  - 9.1.6.4 If a bullet strikes partially within hard cover, and continues on to strike down a scoring metal target, the fallen target will count for score. If a bullet strikes partially within hard cover, and continues on to strike down or hit a metal no-shoot, the fallen no-shoot or hit thereon will count for penalty.
- 9.1.7 Target sticks are neither Hard Cover nor Soft Cover. Shots which have passed wholly or partially through target sticks and which hit a paper or metal target will count for score or penalty, as the case may be.

## **9.2 Scoring Methods**

- 9.2.1 The written stage briefing for each course of fire must specify one of the following scoring methods:

- 9.2.2 “Comstock” – Unlimited time stops on the last shot, unlimited number of shots to be fired, stipulated number of hits per target to count for score.
  - 9.2.2.1 A competitor’s score is calculated by adding the highest value stipulated number of hits per target, minus penalties, divided by the total time (recorded to two decimal places) taken by the competitor to complete the course of fire, to arrive at a hit factor. The overall stage results are factored by awarding the competitor with the highest hit factor the maximum points available for the course of fire, with all other competitors ranked relatively below the stage winner.
- 9.2.3 “Virginia Count” – Unlimited time stops on the last shot, limited number of shots to be fired, stipulated number of hits per target to count for score.
  - 9.2.3.1 A competitor’s score is calculated by adding the highest value stipulated number of hits per target, minus penalties, divided by the total time (recorded to two decimal places) taken by the competitor to complete the course of fire, to arrive at a hit factor. The overall stage results are factored by awarding the competitor with the highest hit factor the maximum points available for the course of fire, with all other competitors ranked relatively below the stage winner.
  - 9.2.3.2 Virginia Count must use paper targets exclusively, and must only be used for Standard Exercises, Classifiers, Speed Shoots, or Short Courses.
- 9.2.4 “Fixed Time” – Limited time, limited number of shots to be fired, stipulated number of hits per target to count for score.
  - 9.2.4.1 A competitor’s score is calculated by adding the highest value stipulated number of required hits, minus penalties. The overall stage results are not factored, and competitors are ranked by the actual net points achieved by them.
  - 9.2.4.2 Fixed Time must use paper targets exclusively and they should, where possible, be disappearing targets.
  - 9.2.4.3 Fixed Time must only be used for Standard Exercises, Classifiers or Short Courses.
  - 9.2.4.4 Fixed Time courses of fire do not incur failure to shoot at or miss penalties.
- 9.2.5 Stage results must rank competitors within the relevant Division in descending order of individual stage points achieved, calculated to 4 decimal places.
- 9.2.6 Match results must rank competitors within the relevant Division in descending order of the combined total of individual stage points achieved, calculated to 4 decimal places.

### **9.3 Scoring Ties**

- 9.3.1 If, in the opinion of the Match Director, a tie in match results must be broken, the affected competitors must shoot one or more courses of fire, nominated or created by the Match Director, until the tie is broken. The result of a tiebreaker will only be used to determine the final placing of the affected competitors, and their original match points will remain unchanged. Ties must never be broken by chance.

### **9.4 Scoring and Penalty Values**

- 9.4.1 Scoring hits on authorized targets will be scored in accordance with the values assigned such targets. (See Appendix B).
- 9.4.2 Each hit visible on the scoring area of a paper no-shoot will be penalized the equivalent of twice the point value of a maximum scoring hit.
- 9.4.3 Each full or partial diameter hit visible on the frontal surface of a metal no-shoot will be penalized the equivalent of twice the point value of a maximum scoring hit, regardless of whether or not it is designed to fall (see Rules 4.3.1.7 and 4.3.1.8).
- 9.4.4 Each miss will be penalized twice the value of the maximum scoring hit available on that target, except in the case of Fixed Time or disappearing targets (see Rules 9.2.4.4 and 9.9.2).
- 9.4.5 In a Virginia Count Course of Fire or a Fixed Time Course of Fire:
  - 9.4.5.1 Extra shots (i.e. shots fired in excess of the number specified in a component string or stage), will each incur one procedural penalty. Additionally, during scoring, no more than the specified number and highest scoring hits will be awarded.
  - 9.4.5.2 Extra hits (i.e. hits on the scoring area of scoring paper targets in excess of the total number specified in the stage), will each incur one procedural penalty. Note that hits on hard cover and/or no-shoots are not treated as Extra Hits.
    - 9.4.5.2.1 On a course of fire using a common firing line (see Rule 2.1.7), a competitor may not be credited or penalized for any scoring or penalty hit(s) which can reasonably be determined by the Range Officer (by caliber, grease mark, or angle of hit) to have been fired by an adjacent competitor.
  - 9.4.5.3 Stacked shots (i.e. obviously shooting more than the required rounds on a target(s) while shooting other target(s) with fewer shots than specified in any string), will incur one procedural penalty per target insufficiently engaged in any string. This penalty will not be applied if the written stage briefing specifically authorizes stacked shots.
- 9.4.6 In a Fixed Time Course of Fire:
  - 9.4.6.1 Overtime shots are shots fired at the targets after the signal to

cease fire has been given. No direct penalties apply to overtime shots fired at disappearing targets.

9.4.6.2 Where static scoring paper targets are used, a shot (or shots) fired more than 0.30 seconds over the set time, will be considered overtime. For example, if the time is 5.00 seconds, a shot (or shots) at 5.31 seconds or more would be considered overtime. Overtime shots will be penalized the maximum possible scoring value of each shot so fired. If the overtime shot results in extra hits on the target, only the specified number of shots may be scored.

9.4.6.3 Where static paper no-shoots are used, it is assumed that all hits occurred within the specified time, and will count in the scoring process.

## **9.5 Scoring Policy**

9.5.1 Unless otherwise specified in the written stage briefing, scoring paper targets must be shot with a minimum of one round each, with the best two hits to score. Scoring metal targets must be shot with a minimum of one round each and must fall to score.

9.5.2 If the bullet diameter of a hit on a scoring target touches the scoring line between two scoring areas, or the line between the non-scoring border and a scoring area, or if it crosses multiple scoring areas, it will be scored the higher value.

9.5.3 If a bullet diameter touches the scoring area of both a scoring target and a no-shoot, it will earn the score and incur the penalty.

9.5.4 Radial tears will not count for score or penalty.

9.5.5 Enlarged holes in paper targets which exceed the competitor's bullet diameter will not count for score or penalty unless there is visible evidence within the remnants of the hole (e.g. a grease mark or a "crown" etc.), to eliminate a presumption that the hole was caused by a ricochet or splatter.

9.5.6 The minimum score for a course of fire or string will be zero.

9.5.7 A competitor who fails to shoot at the face of each scoring target in a course of fire with at least one round will incur one procedural penalty per target for failure to shoot at the target, as well as appropriate penalties for misses (see Rule 10.2.7).

9.5.8 Hits visible on a scoring paper target or no-shoot, which are the result of shots fired through the rear of the target or no-shoot, will not count for score or penalty, as the case may be.

9.5.9 Hits upon scoring or no-shoot paper targets, must completely pass through the target to be considered a valid hit and count for score or penalty.

## **9.6 Score Verification and Challenge**

- 9.6.1 After the Range Officer has declared “Range is Clear”, the competitor or their delegate will be allowed to accompany the official responsible for scoring to verify the scoring.
- 9.6.2 The Range Official responsible for a course of fire may stipulate that the scoring process will begin while a competitor is actually completing a course of fire. In such cases, the competitor’s delegate must be entitled to accompany the official responsible for scoring in order to verify the scoring. Competitors must be advised of this procedure during the squad briefing.
- 9.6.3 A competitor (or his delegate) who fails to verify a target during the scoring process loses all right of appeal in respect of scoring that target.
- 9.6.4 Any challenge to a score or penalty must be appealed to the Range Officer by the competitor (or his delegate) prior to the subject target being painted, patched, or reset, failing which such challenges will not be accepted.
- 9.6.5 In the event that the Range Officer upholds the original score or penalty and the competitor is dissatisfied, he may appeal to the Chief Range Officer and then to the Range Master for a ruling.
- 9.6.6 The Range Master’s ruling will be final. No further appeals are allowed with respect to the scoring decision.
- 9.6.7 During a scoring challenge, the subject target(s) must not be patched, taped or otherwise interfered with until the matter has been settled. The Range Officer may remove a disputed paper target from the course of fire for further examination to prevent any delay in the match. Both the competitor and the Range Officer must sign the target and clearly indicate which hit(s) is (are) subject to challenge.
- 9.6.8 Scoring overlays approved by the Range Master must be used exclusively, as and when required, to verify and/or determine the applicable scoring zone of hits on paper targets.

## **9.7 Score Sheets**

- 9.7.1 The Range Officer must enter all information on each competitor’s score sheet prior to signing it. After the Range Officer has signed the score sheet, the competitor must add his own signature in the appropriate place. Electronic score sheet signatures will be acceptable if approved by the USPSA President. Whole numbers should be used to record all scores or penalties. The elapsed time taken by the competitor to complete the course of fire must be recorded to 2 decimal places in the appropriate place.
- 9.7.2 If corrections to the score sheet are required, these will be clearly entered onto the original and other copies of the competitor’s score sheets. The competitor and the Range Officer should initial any corrections. Corrections are defined as modifications to the score sheet before the RO and Competitor sign off on the score sheet.
- 9.7.3 Should a competitor refuse to sign or initial a score sheet, for any

reason, the matter must be referred to the Range Master. If the Range Master is satisfied that the course of fire has been conducted and scored correctly the unsigned score sheet will be submitted as normal for inclusion in the match scores.

- 9.7.4 A score sheet signed by both a competitor and a Range Officer is conclusive evidence that the course of fire has been completed, and that the time, scores and penalties recorded on the score sheet are accurate and uncontested. The signed score sheet is deemed to be a definitive document. It may only be changed to add penalties under Rule 8.6.2, or to correct arithmetical errors, or by mutual consent of the competitor and the originating Range Officer, or due to an arbitration decision. Changes are defined as modifications to the score sheet after both parties have signed off on the score sheet.
- 9.7.5 If a score sheet is found to have insufficient or excess entries, or if the time has not been recorded on the score sheet, the competitor will be required to reshoot the course of fire.
- 9.7.6 In the event that a reshoot is not possible or permissible for any reason, the following actions will prevail:
  - 9.7.6.1 If the time is missing, the competitor will receive a zero score for the course of fire.
  - 9.7.6.2 If insufficient hits or misses have been recorded on the score sheet, the hits and misses which have been recorded will be deemed complete and conclusive.
  - 9.7.6.3 If excessive hits or misses have been recorded on the score sheet, the highest value scoring hits recorded will be used.
  - 9.7.6.4 Procedural penalties recorded on the score sheet will be deemed complete and conclusive, except where Rule 8.6.2 applies.
  - 9.7.6.5 If the identity of the competitor is missing from a score sheet, it must be referred to the Range Master, who must take whatever action he deems necessary to rectify the situation.
- 9.7.7 In the event that an original score sheet is lost or otherwise unavailable, the competitor's duplicate copy, or any other written or electronic record acceptable to the Range Master, will be used. If the competitor's copy, or any other written or electronic record, is unavailable, or is deemed by the Range Master to be insufficiently legible the competitor will be required to reshoot the course of fire. If the Range Master deems that a reshoot is not possible for any reason, the competitor will incur a zero time and score for the affected course of fire.

## **9.8 Scoring Responsibility**

- 9.8.1 Each competitor is responsible to maintain an accurate record of their scores to verify the lists posted by the Stats Officer.

- 9.8.2 After all competitors have completed a match; the provisional stage results should be published and posted in a conspicuous place at the shooting range by the Stats Officer for the purpose of verification by competitors.
- 9.8.3 If a competitor detects an error in the provisional results at the end of the match, they must file an appeal with the Stats Officer not later than 1 hour after the results are posted. If the appeal is not filed within the time limit, the posted scores will stand and the appeal will be dismissed.
- 9.8.4 Competitors who are scheduled (or otherwise authorized by a Match Director) to complete all courses of fire in a match in a period of time less than the full duration of the match (e.g. 1 day format in a 3-day match etc.), are required to check their provisional match results in accordance with the special procedures and time limits specified by the Match Director (e.g. via a website), failing which scoring appeals will not be accepted. The relevant procedure must be published in advance in match literature and/or by way of a notice posted in a conspicuous place at the shooting range prior to commencement of the match (also see Section 6.5).

## **9.9 Scoring of Moving Targets**

- 9.9.1 Moving scoring targets which present at least a portion of the highest scoring area when at rest following the completion of their designed movement, or which continuously appear and disappear, will always incur failure to shoot at and/or miss penalties (exception see Rule 9.2.4.4). See Appendix B2 or B3 for the percent of target to be presented.
- 9.9.2 Moving scoring targets, which do not comply with the above criteria are considered disappearing targets and will not incur failure to shoot at or miss penalties except where Rule 9.9.3 applies.
- 9.9.3 Moving scoring targets will always incur failure to shoot at and miss penalties if a competitor fails to activate the mechanism which initiates the target movement. This includes no-shoot targets that must be activated when in front of scoring targets to expose them, penalties are based on number of shots required for the scoring target(s) behind the no-shoot.
- 9.9.4 Level I matches only - If the written stage briefing prohibits the engagement of certain targets prior to activation, the competitor will incur one procedural penalty per shot fired at such targets prior to operating the activating mechanism, up to the maximum number of available hits (see Rule 2.1.8.5.1).

## **9.10 Official Time**

- 9.10.1 Only the timing device operated by a Range Officer must be used to



record the official elapsed time of a competitor's attempt at a course of fire. If a timing device is faulty, a competitor whose attempt cannot be credited with an accurate time will be required to reshoot the stage.

- 9.10.2 If, in the opinion of an Arbitration Committee, the time credited to a competitor for a course of fire is deemed to be unrealistic, the competitor will be required to reshoot the course of fire (see Rule 9.7.4).
- 9.10.3 A competitor who reacts to a start signal but for any reason does not fire a shot or continue the attempt at the course of fire and fails to have an official time recorded on the timing device operated by the Range Officer will be given a zero time and zero score for that course of fire.

## **9.11 Scoring Programs**

- 9.11.1 The scoring program approved by USPSA is the EzWinScore. No other scoring program must be used for any USPSA sanctioned match without the prior written approval of the President of USPSA. The most recent version of the scoring program is available from the USPSA website. PDA's or handheld computers may be used for the collection of scoring data for transfer to EzWinScore, provided the program and procedure has been approved by the USPSA President.
- 9.11.2 When electronic scoring is used, once stage scoring is completed, every competitor shall be provided the opportunity to review the PDA or handheld computer display to review their stage time and score entries. At Level II or higher matches, range officers shall also create a hard copy record that includes the hit and penalty totals, time, time of day, competitor initials and range officer initials for each stage.

# **CHAPTER 10: Penalties**

## **10.1 Procedural Penalties – General Regulations**

- 10.1.1 Procedural penalties are imposed when a competitor fails to comply with procedures specified in a written stage briefing. The Range Officer imposing the procedural penalties must clearly record the number of penalties, and the reason why they were imposed, on the competitor's score sheet.
- 10.1.2 Except as specified in Rule 10.2.11, procedural penalties are assessed at twice the value of a single maximum available scoring hit on an USPSA paper target as stated in Appendix B. If the maximum available scoring hit on an USPSA paper target is 5 points, each procedural penalty will be minus 10 points.
- 10.1.3 A competitor disputing the application or number of procedural penalties may appeal to the Chief Range Officer and/or Range Master.

A competitor who continues to be aggrieved may then lodge an appeal for arbitration.

- 10.1.4 Procedural penalties cannot be nullified by further competitor action. For example, a competitor who fires a shot at a target while faulting a line will still incur the applicable penalties even though he subsequently shoots at the same target while not faulting the line.

## **10.2 Procedural Penalties – Specific Examples**

- 10.2.1 A competitor who fires shots while any part of their body is touching the ground or while stepping on an object beyond a Shooting Box or a Fault Line, or who gains support or stability through contact with an object which is wholly beyond and not attached to a Shooting Box or Fault Line, will receive one procedural penalty for each occurrence. However, if the competitor has gained a significant advantage on any target(s) while faulting, the competitor may instead be assessed one procedural penalty for each shot fired at the subject target(s) while faulting. No penalty is assessed if a competitor does not fire any shots while faulting, providing doing so does not violate (2.2.1.5 or 3.2.6) Shots fired after completely (both feet out and touching the ground) leaving a shooting area will be penalized one penalty per shot until the competitor establishes a presence in a new shooting area with at least one foot on the ground inside the shooting area.
- 10.2.2 A competitor who fails to comply with a procedure specified in the written stage briefing will incur one procedural penalty for each occurrence. However, if a competitor has gained a significant advantage during non-compliance, the competitor may be assessed one procedural penalty for each shot fired, instead of a single penalty (e.g. firing multiple shots contrary to the required position or stance).
- 10.2.2.1 Procedural penalties for failure to comply with stage procedures do not apply to the number of shots fired. Penalties for firing insufficient or additional shots are addressed in other rules and must not be penalized under the provisions of 10.2.2.
- 10.2.3 Where multiple penalties are assessed in the above cases, they must not exceed the maximum number of scoring hits that can be attained by the competitor. For example, a competitor who gains an advantage while faulting a Fault Line where only four metal targets are visible will receive one procedural penalty for each shot fired while faulting, up to a maximum of four procedural penalties, regardless of number of shots fired.
- 10.2.4 A competitor who fails to comply with a mandatory reload will incur one procedural penalty for each shot fired after the point where the reload was required until a reload is performed.
- 10.2.5 In a Cooper Tunnel, a competitor who disturbs one or more pieces of the overhead material will receive one procedural penalty for each

piece of overhead material which falls during the course of fire. Overhead material which falls as a result of the competitor bumping or striking the uprights, or as a result of muzzle gases or recoil, will not be penalized.

- 10.2.6 A competitor who is creeping (e.g. moving hands towards the handgun, a reloading device or ammunition) or physically moving to a more advantageous shooting position or posture at the start signal, will incur one procedural penalty.
  - 10.2.6.1 Exception: any movement required or specified in the stage briefing (i.e., self start) will not be penalized.
- 10.2.7 A competitor who fails to shoot at any scoring target with at least one round will incur one procedural penalty per target, plus the applicable number of misses, except where the provisions of Rules 9.2.4.4 or 9.9.2 apply.
- 10.2.8 If a course of fire stipulates shooting strong or weak hand only, a competitor will not be penalized for using the other hand (i.e. the other arm from the shoulder to the hand) to disengage an external safety, to reload or to correct a malfunction. However, the competitor will be issued one procedural penalty per shot fired while:
  - 10.2.8.1 Touching the handgun with the other hand while firing shots;
  - 10.2.8.2 Using the other hand to support the handgun, wrist or shooting arm while firing shots;
  - 10.2.8.3 Using the other hand on a barricade or another prop to increase stability while firing shots.
- 10.2.9 A competitor who leaves a shooting location may return and shoot again from the same location provided they do so safely. However, written stage briefings for Classifiers, Standard Exercises and Level I matches may prohibit such actions, in which case one procedural penalty per shot fired will apply.
- 10.2.10 Special penalty: A competitor unable to fully execute any part of a course of fire due to incapacity or injury may, prior to making his attempt at the course of fire, request that the Range Master apply a penalty in lieu of the stated course requirement.
  - 10.2.10.1 Exception – In a weak hand/strong hand stage, a competitor who has physical use of only one hand may use the same hand for both weak and strong without penalty.
  - 10.2.10.2 If the request is approved by the Range Master, a minimum of one procedural penalty, up to a maximum penalty of 20% of the competitor's points "as shot" (rounded up to the nearest whole number), will be deducted from the competitor's score. For example, if 100 points are available in the course of fire and the competitor actually scores 90 points, the special penalty is a deduction of 18 points. The Range Master may waive any or all procedural penalties in

respect of a competitor who has a significant physical disability prior to the competitor making his attempt at the course of fire.

- 10.2.11 A competitor who commits a Forbidden Action (See Rules 2.3.1.1 and 3.2.6) will be stopped immediately and be subject to disqualification (See Rule 10.6).

### **10.3 Match Disqualification – General Regulations**

- 10.3.1 A competitor who commits a safety infraction or any other prohibited activity during an USPSA match will be disqualified from that match, and will be prohibited from attempting any remaining courses of fire in that match regardless of the schedule or physical layout of the match.
- 10.3.2 When a match disqualification is issued, the Range Officer must record the reasons for the disqualification, and the time and date of the incident, on the competitor's score sheet, and the Range Master must be notified as soon as possible.
- 10.3.3 Scores for a competitor who has received a match disqualification must not be deleted until the time limit prescribed in Rule 11.3.1 has passed.
- 10.3.4 If an appeal to arbitration is submitted within the time limit prescribed in Rule 11.3.1, the provisions of Rule 11.3.2 will prevail.
- 10.3.5 Scores for a competitor who has completed a "pre-match" or main match without a match disqualification will not be affected by a match disqualification received later while that competitor is participating in a Shoot-Off or other side match.

### **10.4 Match Disqualification – Accidental Discharge**

A competitor who causes an accidental discharge must be stopped by a Range Officer as soon as possible. An accidental discharge is defined as follows:

- 10.4.1 A shot, which travels over a backstop, a berm or in any other direction, specified in the written stage briefing by the match organizers as being unsafe. Note that a competitor who legitimately fires a shot at a target, which then travels in an unsafe direction, will not be disqualified (the provisions of Section 2.3 may apply).
- 10.4.2 A shot which strikes the ground within 10 feet of the competitor, except when shooting at a paper target closer than 10 feet to the competitor.
  - 10.4.2.1 Exception — A bullet which strikes the ground within 10 feet of the competitor due to a "squib".
  - 10.4.2.2 In the case of a shot striking a prop where the bullet is deflected or does not continue to strike the ground, if the Range Official determines that the bullet would have struck the ground within 10 feet of the competitor had it not been deflected or stopped by the prop, the provisions of 10.4.2 shall apply.
- 10.4.3 A shot which occurs while loading, reloading or unloading a handgun. This includes any shot fired during the procedures outlined in Rule

8.3.1 and Rule 8.3.7.

10.4.3.1 Exception – a detonation, which occurs while unloading a handgun, is not considered a shot or discharge subject to a match disqualification, however, Rule 5.1.6 may apply.

10.4.4 A shot which occurs during remedial action in the case of a malfunction.

10.4.5 A shot which occurs while transferring a handgun between hands.

10.4.6 A shot which occurs during movement, except while actually shooting at targets.

## **10.5 Match Disqualification – Unsafe Gun Handling**

Examples of unsafe gun handling include, but are not limited to:

10.5.1 Handling a firearm at any time except when in a designated safety area or when under the supervision of, and in response to a direct command issued by, a Range Officer.

10.5.2 If at any time during the course of fire, a competitor allows the muzzle of his handgun to point rearwards, that is further than 90 degrees from the median intercept of the backstop, or in the case of no backstop, allows the muzzle to point up range, whether the handgun is loaded or not (limited exceptions: 10.5.6).

10.5.3 If at any time during the course of fire, or while loading, reloading or unloading, a competitor drops his handgun or causes it to fall, loaded or not. Note that a competitor who, for any reason during a course of fire, safely and intentionally places the handgun on the ground or other stable object will not be disqualified provided:

10.5.3.1 The competitor maintains constant physical contact with the handgun, until it is placed firmly and securely on the ground or another stable object, and

10.5.3.2 The competitor remains within 3 feet of the handgun at all times (except where the handgun is placed at a greater distance, under the supervision of a Range Official, in order to comply with a start position), and

10.5.3.3 The provisions of Rule 10.5.2 do not occur, and

10.5.3.4 The handgun is in the ready condition as specified in Section 8.1, or

10.5.3.5 A self-loading pistol has an empty chamber, the magazine removed and the slide locked open, or

10.5.3.6 A revolver has the cylinder open and empty.

10.5.4 Drawing or holstering a handgun within the confines of a tunnel.

10.5.5 Allowing the muzzle of a handgun to point at any part of the competitor's body during a course of fire (i.e. sweeping).

- 10.5.5.1 Exception – A match disqualification is not applicable for sweeping of the lower extremities (below the belt) while drawing or re-holstering of the handgun, provided that the competitor’s fingers are clearly outside of the trigger guard. This exception is only for holstered handguns. Sweeping does not apply to a handgun holstered in compliance with Rules 5.2.1 and 5.2.7
  
- 10.5.6 While facing downrange, allowing the muzzle of a loaded handgun to point uprange beyond a radius of 3 feet from a competitor’s feet while drawing or re-holstering.
- 10.5.7 Wearing or using more than one handgun at any point in time during a course of fire.
- 10.5.8 Failure to keep the finger outside the trigger guard while clearing a malfunction where the competitor clearly moves the handgun away from aiming at targets.
- 10.5.9 Failure to keep the finger outside the trigger guard during loading, reloading, or unloading. Exception: while complying with the “Make Ready” command to lower the hammer of a gun without a decocking lever, or while initially loading a revolver with a spurless hammer.
- 10.5.10 Failure to keep the finger outside the trigger guard during movement in accordance with Section 8.5.
- 10.5.11 Holstering a loaded handgun, in any of the following conditions:
  - 10.5.11.1 A single action self-loading pistol with the safety not applied.
  - 10.5.11.2 A double action or selective action pistol with the hammer cocked and the safety not applied.
  - 10.5.11.3 A revolver with the hammer cocked.All these conditions apply the entire time the handgun is in the holster.  
See 8.1.2.4
- 10.5.12 Handling live or dummy ammunition (including practice or training rounds, snap caps and empty cases), loaded magazines or loaded speed loading devices in a Safety Area, or failing to comply with Rule 2.4.1. The word “handling” does not preclude competitors from entering a Safety Area with ammunition in magazines or speed loading devices on their belt, in their pockets or in their range bag, provided the competitor does not physically remove the ammunition, loaded magazines or loaded speed loading devices from their retaining or storage device while within the Safety Area.
- 10.5.13 Having a loaded firearm other than when specifically ordered to by the Range Officer.

#### 10.5.14 Retrieving a dropped handgun:

A dropped gun must always be retrieved by a Range Officer who will ensure it is unloaded and properly secured in the competitor's holster or a suitable container. The Range Officer may, at his discretion, secure the gun himself or return it to the competitor who will secure it under supervision of the Range Officer.

Dropping an unloaded handgun or causing it to fall outside of a course of fire is not an infraction; however, a competitor who retrieves a dropped handgun will receive a match disqualification.

#### 10.5.15 Using metal piercing, incendiary and/or tracer ammunition (see Rule 5.5.3), and/or using any ammunition which has been deemed unsafe by a Range Official (see Rule 5.5.5).

10.5.15.1 Ammunition declared unsafe by a Range Official due to multiple squibs, shall not subject the competitor to disqualification.

#### 10.5.16 Drawing a handgun while facing uprange.

#### 10.5.17 A shot fired at a metal target from a distance of less than 23 feet, measured from the face of the target to the nearest part of the competitor's body in contact with the ground (see Rule 2.1.3).

### **10.6 Match Disqualification – Unsportsmanlike Conduct**

10.6.1 Competitors will be disqualified from a match for conduct which a Range Officer deems to be unsportsmanlike. Examples of unsportsmanlike conduct include, but are not limited to, cheating, dishonesty, failing to comply with the reasonable directions of a Match Official, or any behavior likely to bring the sport into disrepute. The Range Master must be notified as soon as possible.

10.6.2 Other persons may be expelled from the range for conduct which a Range Officer deems to be unacceptable. Examples of unacceptable conduct include, but are not limited to, failing to comply with the reasonable directions of a Match Official, interference with the operation of a course of fire and/or a competitor's attempt thereof, and any other behavior likely to bring the sport into disrepute.

10.6.3 A competitor who is deemed by a Range Officer to have intentionally removed or caused the loss of eye or ear protection in order to gain a competitive advantage will be disqualified.

### **10.7 Match Disqualification – Prohibited Substances**

10.7.1 All persons are required to be in complete control both mentally and physically during USPSA matches.

10.7.2 USPSA considers the abuse of alcoholic products, non-prescription and non-essential drugs and the use of illegal or performance enhancing drugs, irrespective of how they are taken or administered, to be an extremely serious offense.

- 10.7.3 Except when used for medicinal purposes, competitors and officials at matches must not be affected by drugs (including alcohol) of any sort during matches. Any person, who in the opinion of the Range Master is visibly under the influence of any of the items described herein, will be disqualified from the match and may be required to leave the range.
- 10.7.4 USPSA reserves the right to prohibit any general or specific substances and to introduce tests for the presence of these substances at any time.

## **CHAPTER 11: Arbitration & Interpretation of Rules**

### **11.1 General Principles**

- 11.1.1 Administration – Occasional disputes are inevitable in any competitive activity governed by rules. It is recognized that at the more significant match levels the outcome is much more important to the individual competitor. However, effective match administration and planning will prevent most if not all disputes.
- 11.1.2 Access - Appeals may be submitted to arbitration in accordance with the following rules for any matter except where specifically denied by another rule. Appeals arising from a disqualification for a safety infraction will only be accepted to determine whether exceptional circumstances warrant reconsideration of the match disqualification. However, the commission of the infraction as described by the Range Official is not subject to challenge or appeal. Challenges to the construction or layout of the course, safety, or shooting conditions may not be submitted after the competitor attempts the course of fire. Should a course of fire be changed after the competitor completes the stage, he is entitled to the process under appeals providing that no DQ has occurred.
- 11.1.3 Appeals – the Range Officer makes decisions initially. If the appellant disagrees with a decision, the Chief Range Officer for the stage or area in question should be asked to rule. If a disagreement still exists, the Range Master must be asked to rule.
- 11.1.4 Appeal to Committee – Should the appellant continue to disagree with the decision he may appeal to the Arbitration Committee by submitting a first party appeal, subsequent to the conditions listed in 11.1.2.
- 11.1.5 Retain Evidence – An appellant is required to inform the Range Master of his wish to present his appeal to the Arbitration Committee and may request that the officials retain any and all relevant documentary or other evidence pending the hearing. Photos, audio and/or video recordings will not be accepted as evidence.
- 11.1.6 Preparing the Appeal - The appellant is responsible for the preparation and delivery of the written submission, together with the appropriate fee. The submission must include relevant rule(s) to support the appeal.



Both the submission and the fee must be submitted to the Range Master within the specified period of time. If not properly prepared, the RM will return the appeal to the competitor who will prepare it correctly and return it to the RM within the specified period of time.

- 11.1.7 Match Official's Duty – Any Match Official in receipt of a request for arbitration must, without delay, inform the Range Master and must note the identities of all witnesses and officials involved and pass this information on to the Range Master.
- 11.1.8 Match Director's Duty – Upon receiving the appeal from the Range Master, the Match Director must convene the Arbitration Committee in a place of privacy as soon as possible.
- 11.1.9 Arbitration Committee's Duty - The Arbitration Committee is bound to observe and apply the current USPSA Rules and to deliver a decision consistent with those rules. Where rules require interpretation or where an incident is not specifically covered by the rules, the Arbitration Committee will use their best judgment consistent with the intent of the rules. The Committee must confer with the MD before changing or removing a course of fire from the match.

## **11.2 Composition of Committee**

- 11.2.1 Arbitration Committee – At Level III/Nationals matches the composition of the Arbitration Committee will be subject to the following rules:
  - 11.2.1.1 The Match Director shall appoint a certified Range Official to serve as Chairman of the committee with one vote.
  - 11.2.1.2 The Match Director shall appoint two arbitrators, with one vote each.
  - 11.2.1.3 Committee members must be competitors in the match and should be certified Range Officials. Match officials are excluded, with the exception of a staff match.
  - 11.2.1.4 Under no circumstances may the Chairman or any member of an Arbitration Committee be a party to, or have a conflict of interest in, the original decision or subsequent appeals which led to the arbitration.
- 11.2.2 Arbitration Committee – For Level I and Level II matches the Match Director shall appoint an Arbitration Committee of three experienced competitors who are not parties to the appeal and who do not have a direct conflict of interest in the outcome of the case. The arbitrators should be certified Range Officials if possible. All committee members will vote. The senior Range Official, or the senior shooter if there are no Range Officials, will be the chairman.

## **11.3 Time Limits and Sequences**

- 11.3.1 Time Limit for Arbitration Request – Written requests for arbitration must be submitted to the Range Master within one hour of the disputed incident or occurrence. Failure to present the required documentation

within the time specified will render the request invalid and no further action will be taken.

- 11.3.2 Decision Time Limit – The Committee must reach a decision within 24 hours of the request for arbitration or before the results have been declared final by the Match Director, whichever comes first. If the Committee fails to render a decision within the prescribed period, both a first and third party appellant (see Section 11.7) will automatically succeed in their appeal, and the fee will be returned.

## **11.4 Fees**

- 11.4.1 Amount – As set by the Match Organizers, the appeal fee to enable an appellant to appeal to arbitration will be US\$100.00 or the equivalent of the maximum individual match entry fee (whichever is lower). An appeal brought by the Range Master in respect of a match issue will not incur a fee.
- 11.4.2 Disbursement and Disposition – If the Committee’s decision is to uphold the appeal, the fee paid will be returned to the appellant.. If the Committee’s decision is to deny the appeal, the appeal fee must be forwarded to NROI. In all cases, the arbitration and decision will be forwarded to NROI. All arbitrations will be posted on the USPSA web site.

## **11.5 Rules of Procedure**

- 11.5.1 Committee’s Duty and Procedure – The Committee will study the written submission and retain on behalf of the organizers the monies paid by the appellant until a decision has been reached.
- 11.5.2 Submissions – The Committee may require the appellant to personally give further details of the submission and may question him on any point relevant to the appeal.
- 11.5.3 Hearing – The appellant may be asked to withdraw while the Committee hears further evidence.
- 11.5.4 Witnesses – The Committee may hear Match Officials as well as any other witnesses involved in the appeal. The Committee will examine all evidence submitted.
- 11.5.5 Questions – The Committee may question witnesses and officials on any point relevant to the appeal.
- 11.5.6 Opinions – Committee members will refrain from expressing any opinion or verdict while an appeal is in progress.
- 11.5.7 Inspect Area – The Committee may inspect any range or area related to the appeal and require any person or official they regard as useful to the process to accompany them.
- 11.5.8 Undue Influence – Any person attempting to influence the members of the Committee in any way other than evidence may be subject to disciplinary action at the discretion of the Arbitration Committee.
- 11.5.9 Deliberation – When the Committee is satisfied that they are in

possession of all information and evidence relevant to the appeal, they will deliberate privately and will reach their decision by majority vote.

## **11.6 Verdict and Subsequent Action**

- 11.6.1 Committee Decision - All committee decisions must cite the rule(s) on which their decision is based. Committee decisions will be reviewed by the Match Director and may be returned to the committee, if necessary, with an explanation of why the decision does not comply with the rules. If the Match Director returns a decision to the Committee, the Committee's next decision must be based on the rules, and must be accepted by the Match Director. When a final decision is reached by the Committee, the Match Director will summon the appellant, the official(s) and the Range Master to present its judgment.
- 11.6.2 Implement Decision – It will be the responsibility of the Range Master to implement the Committee's decision. The Range Master will advise the appropriate match personnel who will post the decision in a place available to all competitors. The decision is not retroactive and will not affect any incidents prior to the decision.
- 11.6.3 Decision is Final – The decision of the Committee is final and may not be appealed unless, in the opinion of the Range Master, new evidence received after the decision warrants reconsideration.
- 11.6.4 Minutes – Decisions of the Arbitration Committee will be recorded and will provide precedent for any similar and subsequent incident during that match.

## **11.7 Third Party Appeals**

- 11.7.1 Appeals may also be submitted by other persons on a “third party appeal” basis. In such cases, all provisions of this Chapter will otherwise remain in force.

## **11.8 Interpretation of Rules**

- 11.8.1 Interpretation of these rules and regulations is the responsibility of the USPSA Director of NROI.
- 11.8.2 Persons seeking clarification of any rule are required to submit their questions in writing, either by fax, letter or email to NROI headquarters.
- 11.8.3 All official USPSA interpretations of the rulebook published on the USPSA website ([www.uspsa.org](http://www.uspsa.org)) will be deemed to be precedents and will be applied to all USPSA matches commencing on or after 7 days from the date of publication. All such interpretations are subject to ratification or modification at a regular or special meeting of the USPSA Board of Directors.

# **CHAPTER 12: Miscellaneous Matters**

## **12.1 Appendices**

All Appendices included herein are an integral part of these rules

## **12.2 Language**

English is the official language of the USPSA Rules. Should there be discrepancies between the English language version of these rules and versions presented in other languages, the English language version will prevail.

## **12.3 Disclaimers**

Competitors and all other persons in attendance at an USPSA match are wholly, solely and personally responsible to ensure that all and any equipment which they bring to the match is fully in compliance with all laws applicable to the geographical or political area where the match is being held. Neither USPSA nor any USPSA Officers, nor any organization affiliated to USPSA nor any officers of any organization affiliated to USPSA accepts any responsibility whatsoever in this regard, nor in respect of any loss, damage, accident, injury or death suffered by any person or entity as a result of the lawful or unlawful use of any such equipment.

Competitors at a USPSA match are solely and personally responsible for the safety of any and all equipment and ammunition they bring to the match. Neither USPSA, nor any USPSA Officers, nor any organization affiliated to USPSA, nor the officers of any organization affiliated to USPSA accepts any responsibility whatsoever in this regard, nor in respect of any loss, damage, accident, injury or death suffered by any person or entity as a result of the lawful or unlawful use of any such equipment and ammunition.

## **12.4 Gender**

References made herein to the male gender (i.e. “he”, “his”, “him”) are deemed to include the female gender (i.e. “she”, “her”).

## **12.5 Measurements**

Throughout these rules, with minor exceptions, measurements are expressed in inches, feet or yards. Measurements expressed in mm or cm in brackets are only provided as a guide.

# APPENDIX A1

## USPSA Match Levels

**Level I** — Club matches conducted on a scheduled basis throughout the year.

**Level II** — Sectional or State matches conducted on an annual basis.

**Level III** — Annual championship matches conducted by USPSA Areas (1 - 8).

**Nationals** — Annual USPSA championship matches.

*Note: Major matches conducted on an irregular or annual basis and which do not represent a specific Section, State, or Area championship shall request either Level II or Level<sup>III</sup> sanctioning.*

**Key:** N/A= Not Applicable, R = Recommended, M = Mandatory

	<b>Match Level:</b>	<b>I</b>	<b>II</b>	<b>III</b>	<b>Nationals</b>
1.	Must follow current USPSA rules	M	M	M	M
2	Competitors must be USPSA members (Section 6.4)	R	M	M	M
3.	Match Director	M	M	M	M
4.	Range Master (certified or appointed)d	M	M	M	M
5	Certified Range Master	N/A	R	M	M
6	Range Master approved by Area Director	N/A	R	M	N/A
7.	Range Master approved by NROI	N/A	R	M	M
8	Certified Chief Range Officer(s)	R	R	M	M
9	Minimum one Certified NROI official per stage	R	M	M	M
10	COF approval by NROI	R	M	M	M
11	COF submitted to Area Director	N/A	M	M	N/A
12	NROI Sanctioning	N/A	M	M	M
13	Chronograph	R	R	M	M
14	1-month advance registration w/NROI	N/A	M	N/A	N/A
15	2-month advance registration w/NROI	N/A	N/A	M	N/A
16	Inclusion in USPSA Match Calendar	N/A	M	M	M
17	Post-match reports to USPSA	N/A	M	M	N/A
18	Recommended minimum rounds	28	75	150	150
19	Recommended minimum stages	2	5	8	8
20	Recommended minimum competitors	10	50	120	120
21	Classifier stages allowed (1)	1 (2)	1	2	N/A

## APPENDIX A2

### USPSA Recognition

Prior to the commencement of a match, the organizers must specify which Division(s) will be recognized.

Unless otherwise specified, USPSA sanctioned matches will recognize Divisions and Categories based on the number of registered competitors who actually compete in the match, based on the following criteria:

#### 1. Divisions

- |                       |   |
|-----------------------|---|
| Level I and Level II  | A minimum of 5 competitors per Division (recommended) |
| Level III / Nationals | A minimum of 10 competitors per Division (mandatory)  |

#### 2. Categories

Division status must be achieved before Categories are recognized.

- |                   |  |
|-------------------|--|
| All level matches | A minimum of 5 competitors per Division Category (see approved list below) |
|-------------------|--|

#### 3. Individual Categories:

Categories approved for individual recognition are as follows:

- |                 |  |
|-----------------|--|
| a. Lady         | Gender as listed on a government issued ID.  |
| b. Junior       | Competitors under the age of 18 on the first day of the match.   |
| c. Senior       | Competitors over the age of 55 on the first day of the match   |
| d. Super Senior | Competitors over the age of 65 on the first day of the match. A competitor over the age of 65 on the first day of the match may enter Senior Category only if Super Senior is unavailable. |
| e. Military     | Military personnel on current active duty orders.  |
| f. Law          | Full-time law enforcement officers with arrest powers.   |

#### 4. Individual Classes:

Division status must be achieved before Classes are recognized.

- |                      |  |
|----------------------|--|
| Level I and Level II | A minimum of 5 competitors per Class (recommended) |
| Level III/Nationals  | A minimum of 10 competitors per Class (mandatory)  |

## APPENDIX A3

### Glossary

Throughout these rules, the following definitions apply:

- Aftermarket .....Items not manufactured by, or available directly from, the Original Firearm Manufacturer. (See OFM)
- Allied equipment       Holsters, magazines, speed loading devices and/or their respective pouches.
- Appearing target       A target which is not visible until activated or revealed.
- Array .....A grouping of more than one target.
- Backstop .....A raised structure of sand, soil or other materials used to contain bullets.
- Behind .....Downrange of and within the lateral confines of the specified object.
- Berm .....A raised structure of sand, soil or other materials used to contain bullets and/or to separate one shooting bay and/or COF from another.
- Bullet .....The projectile in a round intended to strike a target.
- Caliber .....The diameter of a bullet measured in millimeters (or thousandths of an inch).
- Burst Operation .....More than one round can be discharged on a single pull or activation of the trigger.
- Cartridge case .....The main body of a round, which contains all component parts.
- Compensator .....A device fitted to the muzzle end of a barrel to counter muzzle rise (usually by externally diverting escaping gasses).
- Course of Fire .....(Also “course” and “COF”) An expression used interchangeably with “Stage”.
- Cross Draw .....When a competitor draws with their strong hand while wearing their holster on the opposite side of the body.
- Detonation .....Ignition of the primer of a round, other than by action of a firing pin, where the bullet does not pass through the barrel (e.g. when a slide is being manually retracted, when a round is dropped).
- Disappearing target .....A target which when activated and after completing its movement is no longer available for engagement.
- Discharge .....See Shot.

- Draw .....The point at which a handgun is removed or disengaged from the holster so as to allow access to any portion of the interior of the trigger guard.
- Dropped Gun .....(during the course of fire) A condition in which a competitor loses control of their handgun. Loss of control does not require the handgun to land on the ground or other range surface or prop. It occurs anytime the handgun is no longer in control of either hand, even if it is trapped against part of the body or caught in midair.
- Dry firing .....The activation of the trigger and/or action of a firearm which is totally devoid of ammunition.
- Dummy ammunition.....Includes snap caps, empty cases, dummy rounds and any other object that resembles or duplicates a live round.
- Facing Uprange .....Face and feet pointing directly (90°) away from the backstop with shoulders parallel to the backstop.
- Facing Down Range .....The exact opposite of facing uprange.
- False start ..... Beginning an attempt at a COF prior to the “Start signal”.
- Fault Line .....A physical ground reference line in a course of fire which defines the limit(s) of the shooting area.
- Forbidden Action .....A competitor action which has been expressly prohibited by the Range Master and so reflected in the Written Stage Briefing.
- Grain .....A common unit of measurement used in respect of the weight of a bullet (1 grain = 0.0648 grams).
- Handling .....(As in “handling a firearm”) The act of manipulating, holding, or gripping a firearm while the trigger is functionally accessible.
- Kneeling .....A body position wherein at least one knee is in contact with the ground or stage surface.
- Loaded Firearm .....A firearm having a live round, empty case or dummy round in the chamber or cylinder, or having a live or dummy round in a magazine inserted in the firearm.
- Loading .....The insertion of ammunition into a firearm. Loading is completed when ammunition is inserted and firearm is in battery, (slide forward or cylinder closed), and ready to fire.
- Location .....A physical space within the boundaries of a course of fire. For the purposes of this rule, a competitor will



not be considered to have changed location until both feet have moved to a new physical position.

- Match Official ..... A person who has an official duty or function at a match, but who is not necessarily qualified as, or acting in the capacity of, a Range Official.
- Movement ..... Taking more than one step in any direction, or changing body position (e.g. from standing to kneeling, from seated to standing etc.)
- Must ..... This means the same as “will”, “shall”, etc.
- No-shoot(s) ..... Target(s) that incur penalties when hit.
- Not Applicable ..... The rule or requirement does not apply to the particular discipline, Division or match level.
- Off Limits Lines ..... A physical reference line in a course of fire which defines an area of the range floor which is off limits to a competitor during the course of fire.
- OFM ..... Original firearm manufacturer.
- Primer ..... The part of a round which causes a detonation or a shot to be fired.
- Prototype ..... A firearm configuration which is not in mass production and/or is not available to the general public.
- Radial tears ..... Tears in a paper target radiating outwards from the diameter of a bullet hole.
- Range Official ..... A person who is officially serving at a match in the capacity of a Range Officer.
- Reloading ..... The replenishment or the insertion of additional ammunition into a firearm. The reload is not complete until the magazine/speed loader is fully inserted and the firearm is in battery, (slide forward or cylinder closed and ready to fire).
- Remedial Action ..... The term used for correcting any problem to get the firearm back in operation, such as a jam, stuck bullet, or feeding problem due to issues with the magazine, ammunition, or firearm.
- Reshoot ..... A competitor’s subsequent attempt at a course of fire, authorized in advance by a Range Officer or an Arbitration Committee.
- Round ..... A cartridge of ammunition used in a handgun or rifle.
- Securely Fixed (belt) ..... The belt doesn't move when either the gun or a magazine is drawn from it without using both hands.
- Shooting Box ..... A small shooting area (generally square) formed of four connected fault lines.

- Shooting position .....The physical presentation of a person’s body (e.g. standing, sitting, kneeling, prone).
- Shot .....A bullet which passes completely through the barrel of a firearm.
- Should .....Optional but highly recommended.
- Sight picture .....Aiming at a target without actually shooting at it.
- Snap Cap .....(Also “spring cap”) A type of dummy round.
- Squib .....A bullet or solid obstruction lodged inside the barrel of a firearm.
- Stance .....The physical presentation of a person’s limbs (e.g. hands by the side, arms crossed etc.).
- Start position .....The location, shooting position and stance prescribed by a COF prior to issuance of the “Start signal”.
- Static targets .....Targets which are stationary and are not activated.
- Strong hand .....The hand a competitor uses to draw their handgun from their holster.
- Sweeping..... Pointing the muzzle of a firearm at any part of any person’s body.
- Target(s) .....A term that can include both scoring target(s) and no-shoot(s) differentiates between them.
- Tie-down rig .....A holster where the lower section is strapped or rigidly attached to a competitor’s leg.
- Unloading .....The removal of ammunition from a firearm. This action is completed when the firearm is empty of all ammunition and the magazine removed or cylinder opened and shown for inspection by a Range Officer.
- View .....A range of sight or vision *specific to an array of targets*. In order to constitute a new "view" under this rule, the range of sight of an array of targets must be broken by a vision barrier of some sort, such that a different array of targets is seen in the new view.
- Waist level .....The normal wear level for the lower garment. Wearing a belt at waist level, which is deemed to be at the same level as the original belt loops on the lower garment means that the belt is worn at the normal wear level for the pants, trousers, skirt, kilt, shorts or jeans.
- Weak hand .....The hand opposite the strong hand.
- Will .....Mandatory.

## APPENDIX B1

### Target Presentation

Cutting the tops off the stakes provides an improved visual presentation and prevents the stakes from obscuring downrange targets

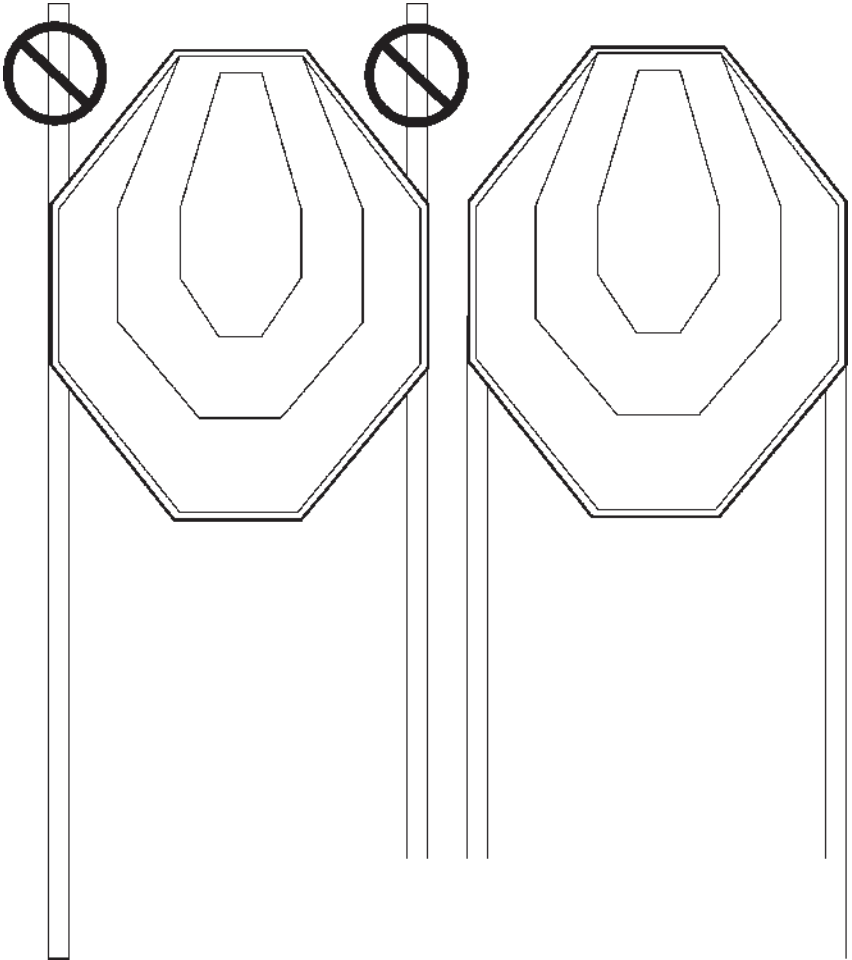

# APPENDIX B2

## Classic Target

At least 25% of the A-zone must remain visible around hardcover or overlapping no-shoots.

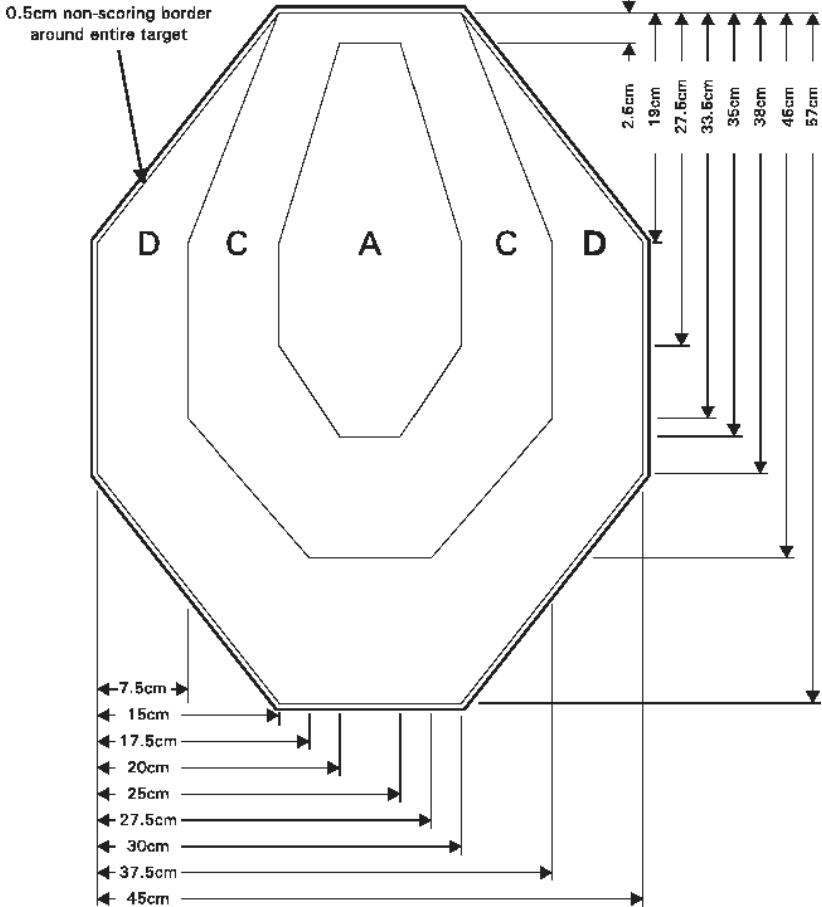

Scoring		
Major	Zone	Minor
5	A	5
4	C	3
2	D	1

## APPENDIX B2 (Cont.)

Minimum amount of A Zone, which must be visible in order to comply with 25% requirement.

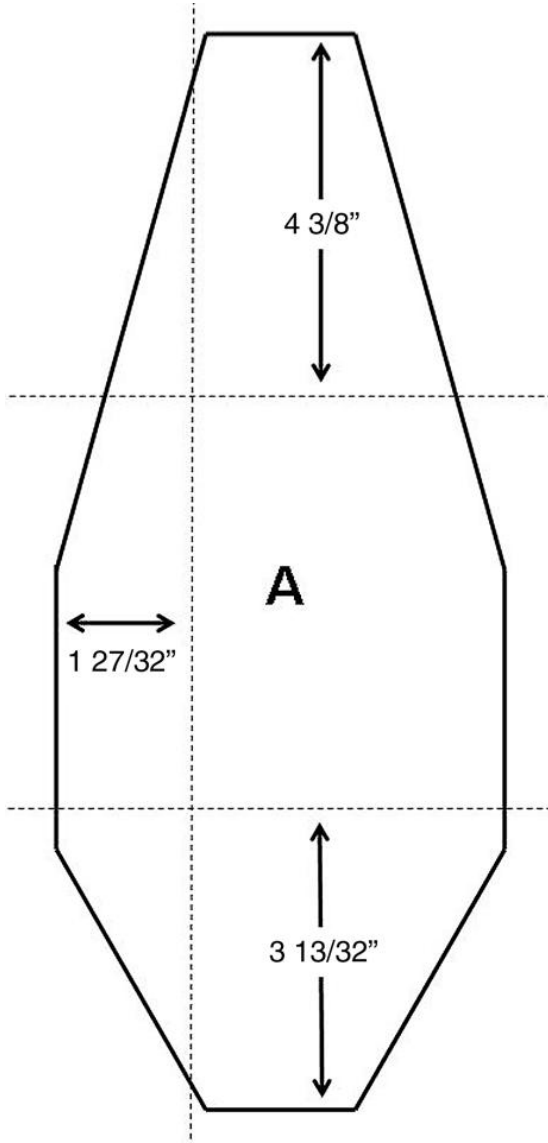

# APPENDIX B3

## Metric Target

**At least 25% of the lower A-zone, or the entire upper A-zone, must remain visible around hardcover or overlapping no-shoots.**

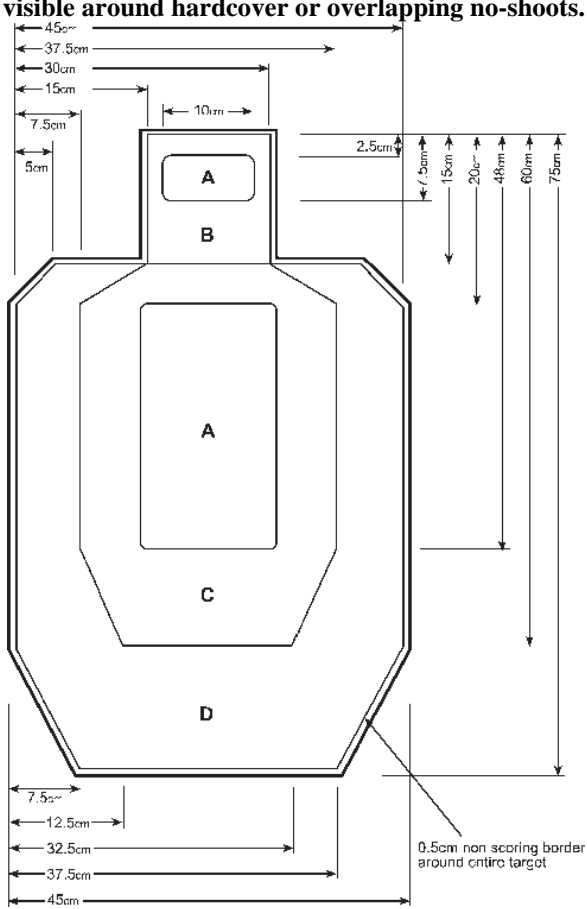

<b>Scoring</b>		
<b>Major</b>	<b>Zone</b>	<b>Minor</b>
<b>5</b>	<b>A</b>	<b>5</b>
<b>4</b>	<b>B</b>	<b>3</b>
<b>4</b>	<b>C</b>	<b>3</b>
<b>2</b>	<b>D</b>	<b>1</b>

# APPENDIX B4

## Popper Calibration Zones

The calibration zone for each target is indicated by the shaded area.

Measurement tolerance on Poppers +/- 1/4 inch

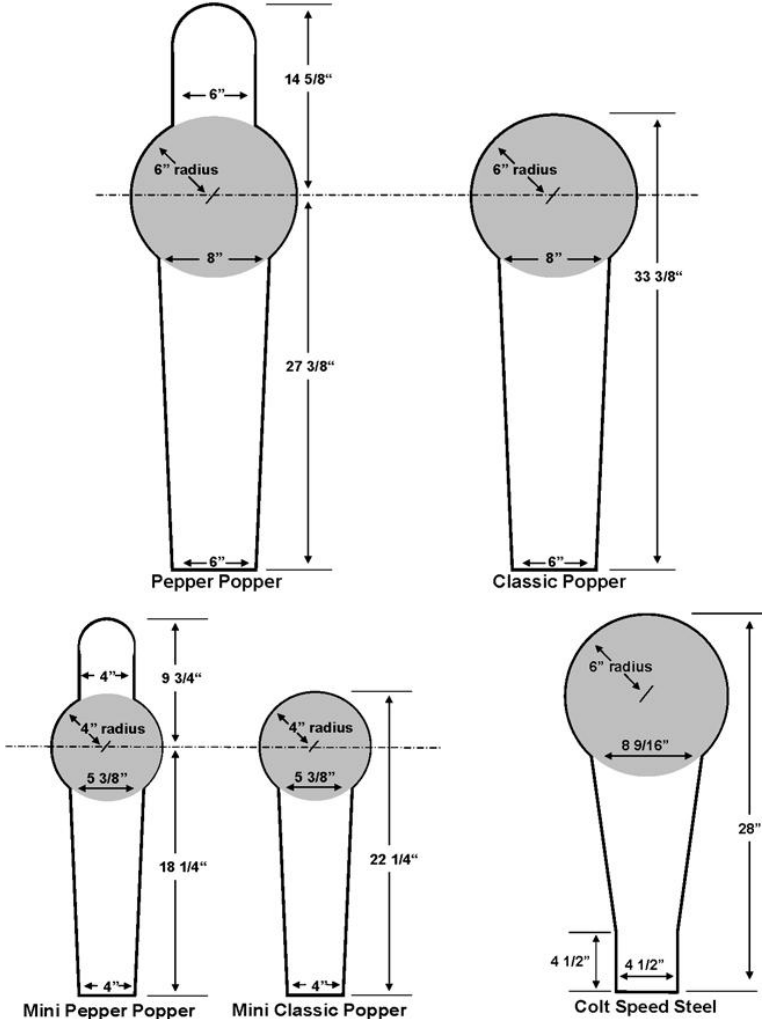

**All Poppers – Scoring value: 5 points (Minor and Major)**

## APPENDIX B5

### Metal Plates

Round		Square or Rectangular
8" diameter (203.20mm)	Minimum dimension	6" each side (152.40mm)
12" diameter (304.80mm)	Maximum dimension	12" each side (304.80mm)
<b>5 points</b>	<b>Scoring value Minor and Major</b>	<b>5 points</b>

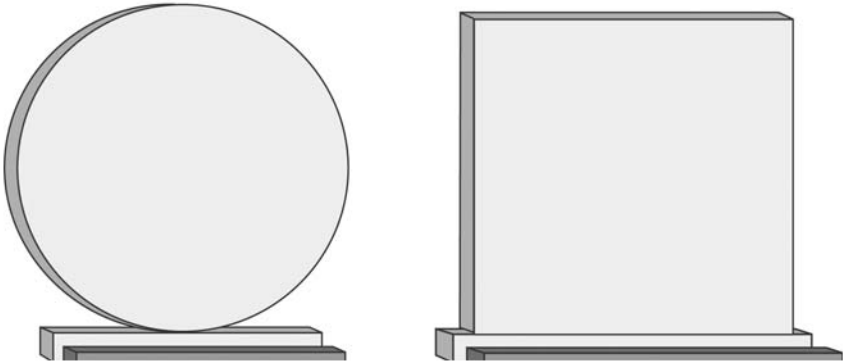

**Measurement tolerance on steel plates +/- 1/4 inch**

#### Construction Note

A small block of wood (indicated by dark shading above), approximately 2cm x 2cm, and about the same width as the plate, should be affixed in front of the base of the plate, to help prevent the plate from turning sideways when shot.



# APPENDIX C1

## Calibration of Poppers

### Initial Calibration

1. The Range Master must designate a specific supply of ammunition and one or more handguns to be used as official calibration tools by officials authorized by him to serve as calibration officers.
2. Prior to commencement of a match, the calibration ammunition must be chronographed using the procedure specified in Appendix C2. The calibration ammunition, when tested through each designated handgun, should achieve a power factor between 115.0 and 125.0 to qualify. 9x19mm is the recommended caliber.
3. Once the supply of ammunition and the designated handguns have been tested and approved by the Range Master, they are not subject to challenge by competitors.
4. The Range Master must arrange for each popper to be calibrated prior to commencement of a match, and whenever required during a match.
5. For initial calibration, each popper must be set to fall when hit within the calibration zone with a single shot fired from a designated handgun using the calibration ammunition. The shot must be fired from the shooting location in the course of fire furthest from the popper being calibrated. Calibration zones are indicated in the diagrams in Appendix B4.

### Calibration Challenges

6. If, during a course of fire, a popper does not fall when hit, a competitor has three alternatives:
  - a. The popper is shot again until it falls. In this case, no further action is required and the course of fire is scored “as shot”.
  - b. The popper is left standing but the competitor does not challenge the calibration. In this case, no further action is required and the course of fire is scored “as shot”, with the subject popper scored as a miss.
  - c. The popper is left standing and the competitor challenges the calibration. In this case, the popper and the surrounding area on which it stands must not be touched or interfered with by any person. If a Match Official violates this rule, the competitor must reshoot the course of fire. If the competitor or any other person violates this rule, the popper will be scored as a miss and the rest of the course of fire will be scored “as shot”. If the popper falls for any non-interference reason (e.g. wind action), before it can be calibrated, Section 4.6 will apply and a reshoot must be ordered.
7. In the absence of any interference, or problem with a target mechanism, a calibration officer must conduct a calibration test of the

subject popper (when required under 6c above), from as near as possible to the point from where the competitor shot the popper. (See rule 4.3.1.5 for Poppers partially hidden by cover).The following will apply:

- a. If the first shot by the calibration officer hits on or below the calibration zone and the popper falls, the popper is deemed to be properly calibrated, and it will be scored as a miss.
  - b. If the first shot fired by the calibration officer hits the popper anywhere on its frontal surface and the popper does not fall, the calibration test is deemed to have failed and the competitor must be ordered to reshoot the course of fire, once the popper has been recalibrated.
  - c. If the first shot fired by the calibration officer hits above the calibration zone, the calibration test is deemed to have failed and the competitor must be ordered to reshoot the course of fire once the Popper has been recalibrated.
  - d. If the first shot fired by the calibration officer misses the popper altogether, another shot must be fired until one of 7a, 7b or 7c occurs.
8. Note that authorized metal plates are not subject to calibration or challenge (see Rule 4.3.1.6).

## APPENDIX C2

### Match Chronograph and Equipment Set-up

#### Chronograph(s):

1. The chronograph(s) must be shielded from the effects of changing sunlight. Setting the chronograph(s) in the shade of a tree, or under a cover which allows a differing amount of sunlight to touch any part of the skyscreens or skyscreen brackets is prohibited. The recommended method for outdoor locations is to use an enclosed “chrono box”. In all locations, the use of either infrared sensors or incandescent lighting provides the most consistent, repeatable results.
2. Two chronographs should be used when possible and set up in tandem so both units measure each shot fired.
3. In all cases, the skyscreens must be positioned and spaced per the manufacturer’s requirements for the chronograph in use. The closest skyscreen must be placed no less than 10 feet from the shooting location.
4. When possible, the chronograph(s) should be run on AC power. If using generator power, the chronograph readings must be monitored for consistency. If using battery power, the battery must be changed or recharged as necessary to insure consistent results.
5. Failing these conditions, or in the absence of a chronograph, the match must use each competitor’s declared Power Factor for match scoring.

#### Scale(s):

6. Scales must be shielded from the wind to prevent errors in measurement while weighing competitor bullets.
7. Two scales are recommended when available, weighing each bullet tested on both scales.
8. Whenever possible, the scale(s) should be run on AC power. If using generator power, the scale readings must be monitored for consistency. If using battery power, the batteries must be changed or recharged as necessary to insure consistent results
9. A set of appropriate check weights must be used in calibrating the scale(s).
10. Failing these conditions, or if a scale is not available, each competitor’s declared bullet weight must be used.
11. If a division as listed in Appendix D requires weighing of a handgun, the same procedure as above will be followed.

#### Bullet Puller(s):

12. Bullet pullers must be of a design which will not damage the bullet or change its weight.

13. If a bullet puller is not available or breaks and a replacement is not available, the declared bullet weight must be used for all subsequent competitors.

#### **Calibration Ammunition:**

14. A sufficient supply of match calibration ammunition must be available and used to calibrate steel targets and (when necessary) verify the match chronograph.
15. To assure consistency, the match calibration ammunition should be comprised of ammunition from the same lot. 9x19mm is the recommended caliber.
16. The ammunition, as fired through each designated handgun, should achieve a power factor between 115.0 and 125.0.

### **Match Chronograph Daily Verification**

#### **Chronograph(s):**

17. Prior to performing any competitor ammunition testing, the Chrono Officer will fire three rounds from the supply of the official match calibration ammunition through the calibration firearm over the chronograph(s) and record the average velocity of the three rounds for each chronograph in use.
18. Dual chronograph configurations are not subject to subsequent daily verification provided that the differential of the velocities between the two chronographs remains reasonably consistent with the differential of the average velocities recorded above.
19. For single chronograph configurations, or whenever one of the dual chronographs fails and cannot be replaced, the single functioning chronograph is subject to subsequent daily verification check. Specifically:
  - a. On each of the following days, the process specified in Item 16 will be repeated using the same firearm and ammunition supply.
  - b. The chronograph is deemed to be within tolerance if the daily average is within +/- 4% of the first day's average.
20. Should a daily variance exceed the allowable tolerance above, the Range Master will take whatever steps necessary to rectify the situation. If more than one chronograph is in use, and only one is out of tolerance, that chronograph can be removed from service and the remaining chronograph can be used alone for the rest of the match.
21. If the Range Master determines that variances or malfunctions make further testing unreliable or impossible, the power factors of competitors who have been successfully tested will stand. The power factors declared by all competitors who have not been tested will be accepted without challenge, subject to any applicable Division requirements.

#### **Scale(s):**

22. Daily, prior to weighing any competitor bullets, the Chrono Officer will

calibrate each scale using the scale's supplied calibration weights per the manufacturer's instructions, following which the scale will be zeroed and a designated check weight(s) will be weighed on each scale and the results recorded.

Daily, prior to weighing any competitor handgun, the Chrono Officer will calibrate each scale using the scale's supplied calibration weights per the manufacturer's instructions, following which the scale will be zeroed and a designated check weight(s) will be weighed on each scale and the results recorded.

23. For the duration of the match, a scale is considered to be in tolerance if
  - a. the scale is able to maintain a weight display stability of +/- 0.1 grain (0.2 ounces in the case of a handgun scale) over a 15 second period, and
  - b. the scale is able to repeat the results of the recorded weights in Item 22 within +/- 0.1 grain, 0.2 ounces in the case of a handgun scale.
24. A scale suspected or found to be out of tolerance will be reset (calibrated and zeroed) and demonstrate satisfactory tolerance prior to being returned to service. Any competitor suspecting a scale is out of tolerance may request that the Range Master be summoned for a ruling.
25. A scale failing Item 23a must be checked for effective wind protection and stable positioning prior to reset.
26. If it is determined that a scale is unable to remain within tolerance or has failed, it must be removed from use. A replacement scale may be utilized if it can be calibrated, zeroed, and be demonstrated to be in tolerance.
27. If more than one scale is in use, and one has failed, the remaining scale can be used alone for the rest of the match.
28. If the Range Master determines that variances or malfunctions make further weight testing unreliable or impossible, the bullet or gun weights declared by all competitors whose bullets or guns have not been weighed will be accepted without challenge, subject to any applicable Division requirements.

## **Competitor Ammunition Collection and Storage**

29. An initial sample of eight rounds of ammunition will be collected from each competitor at a time and place determined by Match Officials. Match Officials may require that a competitor's ammunition be retested at any time during the match and may collect further samples as necessary.
30. It is recommended that ammunition be collected from competitors as randomly as is possible to insure that the collected ammunition accurately matches the ammunition the competitor is actually using in competition.
31. Collected ammunition must be clearly labeled with the competitor's identity.

32. Collected ammunition must be stored in a shaded location, out of the direct effects of the sun. When stored overnight, collected ammunition must be stored indoors at normal room temperature.

### **Competitor Ammunition Testing Procedure**

33. Ammunition must be tested using the competitor's firearm. Prior to and/or during testing, the competitor's firearm and the component parts thereof must not be altered or modified in any way from the condition it is being used (or will be used) at the match. Violations will be subject to Section 10.6.
34. Conventions to be used for all measurements:
  - a. if more than one chronograph is in use, the highest velocity recorded by any of the chronographs shall be used for each respective shot.
  - b. if more than one scale is in use concurrently, the highest weight measured by the scales shall be used for each respective bullet weighed
35. From the eight sample rounds drawn by Match Officials, one bullet is weighed to determine the actual bullet weight and three bullets are fired over the chronograph. Digits displayed on the official match bullet scales and chronograph will be used at face value, irrespective of the number of decimal places indicated on the measuring device used at the match.
36. Power factor is calculated using the bullet weight and the average velocity of the three rounds fired, according to the following formula:  
**Power Factor** = bullet weight (grains) x average velocity (feet per second) / 1000  
The final result will ignore all decimal places (e.g. for USPSA purposes, a result of 124.9999 is not 125).
37. If the resultant power factor fails to meet the declared power factor floor, another three rounds will be fired over the chronograph. The power factor will be recalculated using the bullet weight and the average velocity of the three highest velocity rounds from the six rounds fired.
38. If the power factor is still insufficient, the competitor may elect to have:
  - a. the final bullet pulled and weighed and, if heavier than the first bullet, the power factor calculation in Paragraph 36 will be recalculated using the heavier bullet weight, or
  - b. the final round fired over the chronograph and the power factor recalculated using the first bullet weight, and the average velocity of the three highest velocity rounds from the seven rounds fired.
39. If the resultant power factor fails to meet the Major power factor floor of the relevant Division, the competitor's entire match scores will be recalculated as Minor, if achieved.

40. If the resultant power factor fails to meet the minimum power factor floor for the relevant Division, the competitor may continue shooting the match, but not for score or match recognition.
41. Due to the different methods used by certain chronograph brands to calculate Power Factor, any power factor results produced by the Chrono Station chronograph are considered interim results and subject to confirmation.
  - a. The only official power factor results are produced and/or confirmed by using the formula specified in Item 36 or via the EzWinScore scoring program.
  - b. Specifically, power factors generated by a chronograph which indicate exactly 125.0 or 165.0 shall be subject to confirmation since these values could be the result of the “rounding up” of digits after the first decimal place.
42. If a competitor’s match ammunition is retested, or if any authorized replacement ammunition is used, and different power factors are recorded when tested according to these rules, the lower power factor must be applied to all courses of fire, including those already completed by the competitor.
43. The scores of a competitor who, for any reason, fails to present his firearm for testing at the designated time and location and/or who fails to provide sample rounds for testing whenever requested by a Match Official will be removed from the match results.

## **Chronograph Station Rules and Policies**

44. The Chronograph Station is considered an official stage in the match and subject to all sections of this rule book.
45. The Chrono Officer is the CRO for the chronograph stage and issues range commands appropriate to the requirements of the Chrono Station.
46. Shooters are prohibited from handling their handgun except as specifically required to do so by the Chrono Officer.
47. Unless otherwise authorized by the Chrono Officer, once the handgun is surrendered for testing, it may not be removed from the Chrono Station until the testing is complete.
48. The Chrono Officer will inspect the competitor’s handgun and report any failure of the following to the Range Master:
  - a. Proper function of the handgun’s primary safety mechanism(s)
  - b. Safe condition and operation
  - c. Compliance with the requirements of the declared Division
49. At the command of the Chrono Officer, the competitor may be required to fire up to six rounds into a designated target or spot on the berm/backstop prior to the competitor’s ammunition sample being tested through the chronograph.

50. The Chrono Officer will perform the competitor ammunition testing procedure as specified above and enter the results on a scoresheet suitable for such use.
51. Following testing, should the interim chronograph results be close to the minimum applicable Power Factor floor, it is recommended that any remaining rounds of the competitor's sample ammunition be secured and retained at the Chrono Station for potential later reference or additional testing.
52. A recommended procedure to follow at the chronograph station is to advise the squad/individual competitors not to handle the firearm until instructed. The Chronograph CRO should have a station next to him where the competitor, when called, can step up and when instructed, show a cleared firearm and then place it on the table per the CRO's instructions. The competitor will also provide an empty magazine to be used. The competitor will then step back until the chronograph process is completed. The Chronograph CRO, after the ammo has been tested, will make sure the firearm is empty and then place it on the table and call the competitor to retrieve, clear and holster the firearm. The empty magazine will be returned at this time and the next competitor called to the line.



## APPENDIX C3

### Official Match Ammunition

Competitors using Official Match Ammunition are exempt from the requirements of Appendix C2, Items 38 and 39 as appropriate for the declared power factor.

Source of ammo	Ammo must be delivered to the competitor only at the match where it will be used and designated official by the US Regional Director.
Power Factor	Specific ammo products may be certified as meeting Minor or Major power factor for specific divisions by the US Regional Director
Competitor Declaration	A competitor who wishes to use official match ammo at the certified power factor must file a declaration with the Match Director stating the official ammo product will be in use for the entire match. This declaration must be filed before starting the match.
Withdrawal of Declaration	A competitor who has declared he is using only official match ammo may withdraw the declaration by informing the Range Master prior to use of any non-official ammo.
Ammo Samples	At any match where competitor ammunition will be chronographed, a competitor using official match ammo will be required to provide eight rounds of this ammo at the time they pick up the ammo (delivery sample) and will also be subject to the provisions of Appendix C2, "Competition Ammunition Collection", Item 28.
Ammo Verification	At any match where competitor ammunition will be chronographed, a competitor using official match ammo will have ammo samples collected during the match and chronographed according to the provisions of Appendix C2 #28. Should the ammo so tested fail to meet the declared power factor, it shall be compared against the average of three rounds collected from the official delivery sample. If the samples collected during the match measure more than 10 power factor points below the delivery samples, the measured power factor of the ammo collected during the match shall be used for score and the provisions of Appendix C2, Item 38 or Item 39 shall apply.
Unsportsmanlike Conduct	The use of ammo other than official match ammunition, while declaring use of official ammunition, shall be considered unsportsmanlike conduct.

## APPENDIX D1 — Open Division

1	Minimum power factor for Major	165
2	Minimum power factor for Minor	125
3	Minimum bullet weight	112 grains for major power factor
4	Minimum bullet caliber / cartridge case length	.38 cal. / 9x19 mm (0.354" x 0.748")
5	Minimum bullet caliber for Major	No
6	Minimum trigger pull	No
7	Maximum handgun size	No
8	Maximum magazine length	6.742" (171.25mm)
9	Maximum ammunition capacity	No
10	Max. distance of handgun and mags/speed loaders from inner side of belt	Handgun and Mags - 2"
11	Rule 5.2.3.1 applies	Yes
12	Restriction on position of holster and other equipment	No
13	Optical/electronic sights permitted	Yes
14	Installed flashlights permitted	Yes
15	Compensators permitted	Yes
16	Barrel ports permitted	Yes
17	Slide ports permitted	Yes
18	Maximum weight	No
19	Handgun specifically approved for Division	No
20	Holster restrictions	No
21	Authorized modifications	Not applicable
22	Prohibited modifications	Not applicable

## APPENDIX D2 — Limited Division

1	Minimum power factor for Major	165
2	Minimum power factor for Minor	125
3	Minimum bullet weight	No
4	Minimum cartridge dimensions	9x19 mm (0.354" x 0.748")
5	Minimum bullet caliber for Major	.40 cal. / 10mm (0.40")
6	Minimum trigger pull	No
7	Maximum handgun size	No
8	Maximum magazine length	5.561" (141.25mm) or 6.742" (171.25mm) in single stack guns.
9	Maximum ammunition capacity	No
10	Maximum distance of handgun and mags/speed loaders from inner side of belt	Handgun and Mags - 2"
11	Rule 5.2.3.1 applies	Yes
12	Restriction on position of holster and other equipment	No
13	Optical/electronic sights permitted	No
14	Installed flashlights permitted	No
15	Compensators permitted	No
16	Barrel ports permitted	No
17	Slide ports permitted	Yes
18	Maximum weight	No
19	Handgun specifically approved for Division	N/A
20	Holster restrictions	No

## APPENDIX D3 — Limited-10 Division

1	Minimum power factor for Major	165
2	Minimum power factor for Minor	125
3	Minimum bullet weight	No
4	Minimum cartridge dimensions	9x19 mm (0.354" x 0.748")
5	Minimum bullet caliber for Major	.40 cal. / 10mm (0.40")
6	Minimum trigger pull	No
7	Maximum handgun size	No
8	Maximum magazine length	5.561" (141.25mm) or 6.742" (171.25mm) in single stack guns
9	Maximum ammunition capacity	Yes, maximum 10 rounds loaded in any magazine after the start signal
10	Maximum distance of handgun and mags/speed loaders from inner side of belt	Handgun and Mags - 2"
11	Rule 5.2.3.1 applies	Yes
12	Restriction on position of holster and other equipment	No
13	Optical/electronic sights permitted	No
14	Installed flashlights permitted	No
15	Compensators permitted	No
16	Barrel ports permitted	No
17	Slide ports permitted	Yes
18	Maximum weight	No
19	Handgun specifically approved for Division	Yes — see Special Conditions
20	Holster restrictions	No

**Special conditions: See exceptions above.**

APPENDIX D4—Production Division

1	Minimum power factor for Major	Not Applicable
2	Minimum power factor for Minor	125
3	Minimum bullet weight	No
4	Minimum caliber/cartridge case length	.38/9mm (0.354" x 0.748")
5	Minimum bullet caliber for Major	NA
6	Minimum trigger pull	No
7	Maximum size, handgun and all magazines (revolvers are exempt)	Yes. Handgun with empty magazine inserted must fit wholly within a box with internal dimensions of 8 15/16" x 6" x 1 5/8" (tolerance +1/16", - 0") (8.938" x 6" x 1.625") (227.01mm x 152.40mm x 41.28mm)
8	Maximum magazine length	See #7
9	Maximum ammunition capacity	Yes. Maximum 10 rounds loaded in any magazine after the start signal.
10	Maximum distance of handgun and mags/speed loaders from inner side of belt.	Handgun and mags, 2"
11	Rule 5.2.3.1 applies	Yes
12	Restrictions on position of holster and other equipment	Yes. See Appendix E3 (revolver speed loaders and moon clips are exempt)
13	Optical/Electronic sights permitted	No. Notch and post type only
14	Installed Flashlights permitted	No
15	Compensators permitted	No
16	Barrel Ports permitted	No
17	Slide Ports permitted	Yes, on factory original approved models
18	Maximum weight	Yes. <b>4 ounces</b> with empty magazine inserted <u>over</u> OFM weight listed on approved pistol list
19	Handgun specific approval for Division	Yes. See Special Conditions
20	Holster and Magazine Holder restrictions	<ul style="list-style-type: none"> <li>• Suitable for everyday use. Race Gun type holsters prohibited</li> <li>• May not be manufactured or cut lower than, and must cover the slide up to, 1/2" below the ejection port (belt slide "Yaqui" type holster is exempt)</li> <li>• Revolver holsters open no lower than halfway down the cylinder</li> <li>• The drop offset type holster is allowed in Production division as long as the heel of the butt of the gun is above the belt per 5.2.7.2, and the rest of the criteria are met</li> <li>• Each magazine must be contained individually within the magazine pouch. Magazines may not be retained through magnetic means.</li> </ul>

APPENDIX D4—Production Division

21	Authorized modifications (strictly limited to these items and their stated guidelines)	Please note that, during a match, a competitor may be required to demonstrate that their gun complies with Division rules by identifying a specific rules clause or published interpretation authorizing any disputed modification. If the competitor cannot identify an authorizing rules clause or published interpretation, the RM shall rule that the modification is PROHIBITED for Production division use and shall move the competitor to Open Division.
21.1	Internal throating and polishing to improve accuracy, reliability and function	Internal modifications which do not conflict with other clauses of this appendix are ALLOWED. Special Notes/Clarifications: <ul style="list-style-type: none"> <li>• See 21.3 for specifics with regard to slides and barrels</li> <li>• ALL Factory safety mechanisms, whether internal or external, must remain functional</li> <li>• See 22.1 for specifics on external safeties</li> <li>• Any internal modifications which result in a visible change to the external appearance of the gun when it is in battery REMAIN PROHIBITED unless specifically allowed by the plain language herein.</li> </ul>
21.2a	Slide and Frame Refinishing	Cosmetically enhancing the finish of a slide and/or frame is ALLOWED in Production Division, provided that the finish provides no competitive advantage, and subject to the existing constraints on refinishing (cosmetic only, no competitive advantage.)
21.2b	Milling of Slide	A slide may be modified specifically for installing sights, and for no other purpose.
21.3	Aftermarket slides and barrels	<p><u>SLIDES</u>: You may replace the slide with an OFM or aftermarket slide of the same length, contour and caliber as the original slide for that model of gun.</p> <p><u>BARRELS</u>: You may replace the barrel with an OFM or aftermarket barrel which is of the same length, and caliber as the original barrel for that model of gun.</p> <p>Special Notes/Clarifications: A barrel within +/- 0.1" of OFM is the same length. Barrels of the same length and caliber but with different crown profiles are authorized.</p>
21.4	Grips	<ul style="list-style-type: none"> <li>• Grip modifications such as, but not limited to, undercutting/smoothing the trigger guard, adding or removing finger grooves, or adding stippling, grip tape, or checkering are allowed. Replacement grip panels are allowed provided they do not extend below the butt of the gun to form a make-shift magwell.</li> <li>• Revolver grips may be replaced with OFM or aftermarket grips of any shape, profile and surface texture.</li> </ul> <p>Special Notes/Clarifications: See 22.2, below, for specifics with regard to modifications on revolver grips.</p>
21.5	Exchange of minor INTERNAL components	<p><b>INTERNAL</b> parts: A broad range of INTERNAL parts may be modified or replaced – either with OFM or aftermarket parts.</p> <p><u>Special Notes/Clarifications</u>:</p> <ul style="list-style-type: none"> <li>• Strikers, sears, springs, connectors/disconnectors, and any other part which is NOT visible when the gun is in battery is considered an INTERNAL part and may be modified or replaced unless otherwise prohibited in these provisions (see section 22 for specific prohibitions).</li> <li>• Guide rods are considered an “internal part” and may be modified and/or replaced with OFM or after-market guide rods even though part of the guide rod is externally visible when the gun is in battery. <b>Note that the weight limits in D4-18 remain in force and relevant.</b></li> <li>• Internal magazine disconnects are legal as they are internal parts that do not show while in battery.</li> </ul>

APPENDIX D4—Production Division

21.6	Exchange of minor External components	Sights, firing pins, firing pin retainers, pins, extractors, magazine releases, slide stops, thumb safeties, triggers, hammers, bushings, and ejectors MAY be replaced with OFM or aftermarket parts.
21.7	Magazines	OFM and aftermarket magazines and base-pads may be used. However, any and all magazines used in competition must fit into the USPSA box while empty and inserted in the handgun as described in item 7 of this appendix. Grip tape and/or skate board tape are specifically allowed on magazines and base-pads.
22	Specifically prohibited modifications and features	Please note that the absence of an item in the list of prohibited modifications MAY NOT be construed to mean a modification is allowed. A modification is only allowed in Production Division if there is a rules clause or interpretation that specifically declares that it is allowed in the Division. Removing or disabling firing-pin blocks or any other factory safety mechanism in Production division is specifically prohibited.
22.1	Disabling of any external safety or externally operated safety	External and externally operated safety mechanisms must remain operable.  <u>Special Notes/Clarifications:</u> <ul style="list-style-type: none"> <li>• For purposes of this clause, a “trigger safety” is externally visible, and must remain operable.</li> <li>• For purposes of this clause, the prohibition on “disabling” means that you may NOT modify an external safety mechanism in any way that affects its function as a safety per the OFM design.</li> <li>• For purposes of this clause, a magazine disconnect is NOT considered a safety mechanism, and may be removed.</li> </ul> <p>Please note that other clauses in the body of the competition rules require that a “trigger mechanism must, at all times, function safely” (5.1.4), that handguns must be “serviceable and safe” (5.1.6) and that the Range Master is the final authority on the definition of “safety” as it pertains to the mechanism of the gun (8.1.2.4). It is the competitor’s responsibility to be able to demonstrate at any time that all factory safety mechanisms are functional, regardless of whether they are internal or external.</p>
22.2	Grips	Non OFM grip modifications (addition or removal of material) that provide function, such as a beavertail or thumbrest, or prohibited. Revolver grips may be replaced with grips of any shape, profile, or texture. Adding or removing material to change the profile of Revolver grips is ALLOWED.
22.3	External Plugs (such as Seattle Slug)	External plugs which alter the grip profile or extend past the bottom of the grip are PROHIBITED.
22.4	Magwell Opening	No OFM or aftermarket external magwells. <u>Internal</u> magwell dimensions may be increased. Aftermarket external flaring is prohibited.

**Special conditions:**

1. Handguns with external hammers must be fully decocked at the start signal. If a decocking lever is installed and used, the term fully decocked is the position where the hammer rests once the decocking lever has been used. Altering a factory installed decocker to bring the hammer to rest at less than a half cocked position is not allowed. Manually decocked hammers must be fully down.
2. Unless specifically authorized above, modifications are prohibited. Except for Item 7, revolvers are subject to all restrictions above, unless otherwise noted.
3. A handgun may be approved and added to the USPSA Approved Production Handgun List after the NROI Manufacturer’s Declaration form stating that a minimum of 2000 complete handguns have been manufactured and available to the general public has been submitted and NROI has inspected the handgun for compliance.
4. Anyone signing up for Production is declaring minor regardless if the ammunition makes major at the chronograph. Should they be moved to another division, they will shoot minor for the entire match or sub-minor should their ammo fail to meet the minimum.

UNLESS a modification is SPECIFICALLY authorized in the rules or SPECIFICALLY authorized in an official, published NROI interpretation, it is considered a PROHIBITED MODIFICATION.

## APPENDIX D5 — Single-Stack Division

1	Minimum power factor for Major	165
2	Minimum power factor for Minor	125
3	Minimum bullet weight	No
4	Minimum bullet caliber / cartridge case length	.38 cal. / 9x19 mm (0.354" x 0.748")
5	Minimum bullet caliber for Major	.40 cal. / 10mm (0.40")
6	Minimum trigger pull	No
7	Maximum size Handgun and all magazines	Yes, handgun with empty magazine inserted must fit wholly within a box with internal dimensions of 8 15/16" x 6" x 1 5/8" (tolerance +1/16", -0") (8.938" x 6" x 1.625") (227.01mm x 152.40mm x 41.28mm)
8	Maximum magazine length	See # 7 above
9	Maximum ammunition capacity	Yes, maximum rounds loaded in any magazine after the start signal - Major Power Factor - 8 rounds - Minor Power Factor - 10 rounds
10	Max. distance of handgun and mags/speed loaders from inner side of belt	Handgun and Mags - 2"
11	Rule 5.2.3.1 applies	Yes
12	Restriction on position of holster and other equipment	Yes, see Appendix E3
13	Optical/electronic sights permitted	No, notch and post only
14	Installed flashlights permitted	No
15	Compensators permitted	No
16	Barrel ports permitted	No
17	Slide ports permitted	No
18	Maximum weight	Yes, 43 ounces with empty magazine
19	Handgun specific approval for Division	See Special Conditions below
20	Holster and magazine holder restrictions	<ul style="list-style-type: none"> <li>•Suitable for everyday use. "Race gun" type holster prohibited.</li> <li>•Must carry pistol so that the entire front strap (to the trigger guard) is at or above the top of the belt. Female shooters must carry the pistol no lower than the heel of the butt at the top of the belt.</li> </ul>



20	Cont.	<ul style="list-style-type: none"> <li>•May not be manufactured or cut lower than, and must cover the slide up to, 1/2” below the ejection port (belt slide “Yaqui” type holster exempt).</li> </ul> <p>Each magazine must be contained individually within the magazine pouch. Magazines may not be retained through magnetic means.</p>
21	Authorized modifications	<p>Milling of the slide to insert sights, add or remove serrations, such as cocking or flat topping, tri-topping the slide, lowering ejection ports, cuts that are minor and cosmetic in nature are permitted.</p> <p>Duplicating features that are on a factory, mass produced slide available to the general public is permitted. Cuts that are designed to specifically or significantly lighten the slide, such as holes, or slots, are ruled as competitive advantage and prohibited.</p>
22	Prohibited modifications and features	<ul style="list-style-type: none"> <li>•External modifications or features such as weights or devices to control or reduce recoil (such as, but not limited to, thumb rests or components which could be used as such).</li> <li>•Coned barrels, bull barrels, or barrels with flanges, except in 1911 compact pistols with a barrel length of 4.20 inches or less. (Note: All other barrels must have barrel bushings and conform to factory profile).</li> <li>•Slide lightening, cuts, ports, or any milling deemed to provide a competitive advantage.</li> </ul>
23	Permitted features	<ul style="list-style-type: none"> <li>•External extractors, firing pin blocks, and other factory safety features.</li> <li>•Duplicating features that are on a factory, massed produced slide available to the general public.</li> <li>•Factory installed light rail attachments if the dust cover is no longer than 3.25 inches measured from the rear of the slide stop pin to the front of the dust cover.</li> </ul>

## **APPENDIX D5 — Single-Stack Division Cont.**

### **Special conditions:**

- Only 1911 production type pistols. Must be available to the general public and have their basis in the original 1911 service pistol as designed by John M. Browning. Pistols made from components that duplicate the factory originals are acceptable. Frames must be metal.

## APPENDIX D6 — Revolver Division

1	Minimum power factor for Major	165
2	Minimum power factor for Minor	125
3	Minimum bullet weight	No
4	Minimum bullet caliber / cartridge case length	.38 cal. / 9x19 mm (0.354" x 0.748")
5	Minimum bullet caliber for Major	No
6	Minimum trigger pull	No
7	Maximum handgun size	No
8	Maximum magazine length	Not applicable
9	Maximum ammunition capacity	No, maximum of 6 rounds fired before reload if Major PF declared, 8 if minor PF declared.
10	Max. distance of handgun and mags/speed loaders from inner side of belt	Handgun and Mags - 2"
11	Rule 5.2.3.1 applies	Yes
12	Restriction on position of holster and other equipment	No
13	Optical/electronic sights permitted	No
14	Installed flashlights permitted	No
15	Compensators permitted	No
16	Barrel ports permitted	No
17	Slide ports permitted	Not applicable
18	Maximum weight	No
19	Handgun specific approval for Division	No (see Special Conditions below)
20	Holster restrictions	No
21	Authorized modifications	Not applicable
22	Prohibited modifications	Not applicable

### Special conditions:

- “Self-loading” revolvers with retractable slides are prohibited in this Division.

## APPENDIX D7, CARRY OPTICS

1	Minimum Power Factor for Major	Not Applicable
2	Minimum Power Factor for Minor	125
3	Minimum bullet weight	NO
4	Minimum bullet caliber / cartridge case length	9x19 mm (0.354" x 0.748")
5	Minimum bullet caliber for Major	Not Applicable
6	Minimum trigger pull	NO
7	Maximum size Handgun	NO
8	Maximum magazine length	Yes, 141.25 mm (5.561")
9	Maximum ammunition capacity	No
10	Max. distance of handgun and mags/speed loaders from inner side of belt	Handgun and Mags - 2"
11	Rule 5.2.3.1 applies	Yes
12	Restriction on position of holster and other equipment	Yes, see Appendix E3. <b>Optic/sights are exempt.</b>
13	Optical/electronic sights permitted	Optical/electronic sights REQUIRED; must be attached directly to slide between rear of slide and ejection port, and may not be mounted to the frame in any way
14	Installed Flashlights Permitted	NO
15	Compensators Permitted	NO
16	Barrel Ports Permitted	NO
17	Slide Ports Permitted	Yes
18	Maximum weight	Yes, 45 oz., including optic and empty magazine
19	Handgun specific approval for Division	Yes, see Special Conditions
20	Holster and magazine holder restrictions	<ul style="list-style-type: none"> <li>•Suitable for everyday use. "Race gun" type holster prohibited.</li> <li>•May not be manufactured or cut lower than, and must cover the slide up to, 1/2" below the ejection port (belt slide "Yaqui" type holster exempt).</li> <li>•The drop offset type holster is allowed in Carry Optics Division as long as the heel of the butt of the gun is above the belt per 5.2.7.2 and the rest of the criteria are met.</li> <li>•Each magazine must be contained individually within the magazine pouch. Magazines may not be retained through magnetic means.</li> </ul>
21	Authorized modifications (Strictly limited to these items and their stated guidelines)	Please note that, during a match, a shooter may be required to demonstrate that their gun is in compliance with Division rules by identifying a specific rules clause or published interpretation, which authorizes any disputed modification. If the shooter cannot identify an authorizing rules-clause or published interpretation, the RM shall rule that the modification is PROHIBITED for Carry Optics use and shall move the shooter to Open Division.

21.1	Internal throating and polishing to improve accuracy, reliability and function.	INTERNAL modifications which do NOT conflict with other clauses of this appendix are ALLOWED. Special Notes/Clarifications: • See 21.3 for specifics with regard to slides and barrels. • ALL factory safety mechanisms, whether internal or external, must remain functional. • See 22.1 for specifics on external safeties. • Per existing NROI ruling, any “internal” modifications which result in a visible change to the external appearance of the gun when it is in battery REMAIN PROHIBITED unless specifically allowed by the plain language herein.
21.2a	Slide & Frame – refinishing	Cosmetically enhancing the finish of a slide or frame is ALLOWED in Carry Optics Division. Stippling on the frame to provide texture or additional grip surface is specifically allowed.
21.2b	Milling of slide	A slide may be modified specifically for the purpose of installing optical sights or cocking serrations. Textured finishes, grip tape, milling or stippling on the slide to provide texture is also allowed. Cuts designed to specifically or significantly lighten the slide, such as holes, are allowed.
21.3	After-market slides and barrels	<u>SLIDES</u> : Current rules remain in effect – You may replace the slide with an OFM <u>or</u> aftermarket slide of the same length, contour and caliber as the original slide for that model of gun. <u>BARRELS</u> : Current rules remain in effect - you may replace the barrel with an OFM <u>or</u> aftermarket barrel of the same length and caliber as the original barrel for that model of gun. Special Notes/Clarifications: A barrel within +/- 0.1” of OFM is the same length. Barrels of the same length and caliber but with different crown profiles are authorized.
21.4	Grips	Replacement grip panels are allowed provided they do not extend below the butt of the gun to form a make-shift magwell. Grip modifications such as, but not limited to, undercutting/smoothing the trigger guard, adding or removing finger grooves, or adding stippling, grip tape, or checkering are specifically allowed. Grip tape or grip sleeves cannot disengage a grip safety. Grips may not be modified to create a thumb rest or beavertail.

21.5	Exchange of minor INTERNAL components (strickers, sears, springs, connectors/disconnectors, and other wholly-internal parts)	<p><b>INTERNAL</b> parts: A broad range of INTERNAL parts may be modified or replaced – either with OFM or aftermarket parts.</p> <p>Special Notes/Clarifications: • Strickers, sears, springs, connectors/disconnectors, and any other part which is NOT visible when the gun is in battery is considered an INTERNAL part and may be modified or replaced unless otherwise prohibited in these provisions (see section 22 for specific prohibitions).</p> <ul style="list-style-type: none"> <li>• Guide rods are considered an “internal part” and may be modified and/or replaced with OFM or after-market guide rods even though part of the guide rod is externally visible when the gun is in battery. Note that the weight limits in D4-18 remain in force and relevant.</li> <li>• Internal magazine disconnects are legal as they are internal parts that do not show while in battery.</li> </ul>
21.6	Exchange of minor EXTERNAL components	<p>Sights, firing pins, firing pin retainers, pins, extractors, magazine releases, slide stops, thumb safeties, triggers, hammers, bushings, and ejectors MAY be replaced with OFM or aftermarket parts.</p> <ul style="list-style-type: none"> <li>• Barrels are considered “external parts” and are subject to specific restrictions in 21.3.</li> </ul>
21.7	Magazines	<p>OFM and aftermarket magazines and base-pads may be used. Grip tape and/or skateboard tape are specifically allowed on magazines and base-pads.</p>
22	Specifically prohibited modifications and features	<p>Please note that the absence of an item in the list of prohibited modifications MAY NOT be construed to mean a modification is allowed. A modification is only allowed in Carry Optics Division if there is a rules clause or interpretation, which specifically declares that it is allowed in the Division.</p> <p>Removing or disabling firing-pin blocks or any other factory safety mechanism in Carry Optics division is specifically prohibited.</p>
22.1	Disabling of any external safety or externally operated safety	<p>External and externally operated safety mechanisms must remain operable. Special Notes/Clarifications:</p> <ul style="list-style-type: none"> <li>• For purposes of this clause, a “trigger safety” is externally visible, and must remain operable.</li> <li>• For purposes of this clause, the prohibition on “disabling” means that you may NOT modify an external safety mechanism in any way that affects its function as a safety per the OFM design.</li> <li>• For purposes of this clause,</li> </ul>

		<p>a magazine disconnect is NOT considered a safety mechanism, and may be removed. Please note that other clauses in the body of the competition rules require that a “trigger mechanism must, at all times, function safely” (5.1.4), that handguns must be “serviceable and safe” (5.1.6) and that the Range Master is the final authority on the definition of “safety” as it pertains to the mechanism of the gun</p> <ul style="list-style-type: none"> <li>• (8.1.2.4). It is the competitor’s responsibility to be able to demonstrate at any time that all factory safety mechanisms are functional, regardless of whether they are internal or external.</li> </ul>
22.2	External plugs (such as Seattle Slug)	<p>Remains in effect – external plugs which alter the grip profile or extend past the bottom of the grip are PROHIBITED</p> <p>External plugs which do not alter the grip profile (flush fit) are specifically allowed.</p>
22.3	Magwell opening	External flaring remains PROHIBITED.

**Special conditions:**

- Semi-Auto pistols only
- Handguns with external hammers must be fully decocked at the start signal. If a decocking lever is installed and used, the term fully decocked is the position where the hammer rests once the decocking lever has been used. Altering a factory installed decocker to bring the hammer to rest at less than a half cocked position is not allowed. Manually decocked hammers must be fully down.
- A handgun may be approved specifically for Carry Optics division provided that the model of the pistol used is an approved Production Division model AND meets Carry Optics criteria. Any pistol that is not on the approved Production list, but meets Carry Optics criteria must submit a Manufacturers Declaration Form to DNROI stating that a minimum of 500 complete handguns have been manufactured and are available to the general public
- Anyone signing up for Carry Optics is declaring minor regardless if the ammunition makes major at the chronograph. Should they be moved to another division, they will shoot minor for the entire match or sub-minor should their ammo fail to meet the minimum.
- UNLESS a modification is SPECIFICALLY authorized in the rules or SPECIFICALLY authorized in an official, published NROI interpretation, it is considered a PROHIBITED MODIFICATION.

Appendix D8--Pistol Caliber Carbine Division

1	Minimum Barrel Length **see Special Conditions**	None (See special conditions.)
2	Approved/Permitted Calibers	9mm, .357 Sig, .40 S&W, 10mm, .45 ACP
3	Minimum Power Factor	125 **Minor Scoring Only**
4	Maximum Velocity **Minor Scoring Only**	1600 FPS
5	Magazine Capacity Limit	None
6	Must have stock attached and be capable of being fired from shoulder position. **Note: Sig Brace and any variant thereof is not allowed** Handgun to carbine conversions are allowed, provided they meet the criteria above.**see Special Conditions**	Yes, see 5.1.10.
7	Sling use authorized	Yes
8	Optical sight/electronic sights permitted	Yes
9	Compensators /Muzzle Brakes permitted	Yes
10	Flash Hiders permitted	Yes
11	Suppressors permitted	No
12	Rules References	All references to “handgun” are deemed to apply to PCC as well, except where the terms “holstering”, “drawing”, or “re-holstering” are referenced, and where otherwise noted. PCC specific rules are in the PCC rules addendum.
13	Lasers/Flashlights	Yes
14	Magazine and Magazine holder restrictions	No side-by-side magazine couplers allowed. Magazines must be carried on the belt or in apparel pockets. See rule 5.2.4. No restriction on location on the belt. No thigh rigs or tie down magazine holders. End-to-end coupling/extension is allowed.
15	Full Auto/ “Burst” Capabilities (one trigger pull fires more than one round--see special conditions)	Permitted, but semi-auto function only, see PCC 5.1.11, PCC 5.1.12, PCC 10.5.18
16	Binary Triggers (firearm fires once on trigger pull and once on release)	Not Allowed

Special Conditions:

- 1) Short Barreled Rifles (SBR’s) are permitted provided that the competitor is in full compliance with all state and federal laws and regulations concerning ownership and transport of the SBR.



- 2) Handgun to carbine conversions are allowed as long as the conversion is shot in PCC division, and meets the criteria in #6.
- 3) Full auto, burst fire, mechanically aided bump fire, and binary fire will result in a procedural on the first instance, and a disqualification for any subsequent occurrences, (unsafe gun handling, see PCC 10.5.18).

## APPENDIX E1

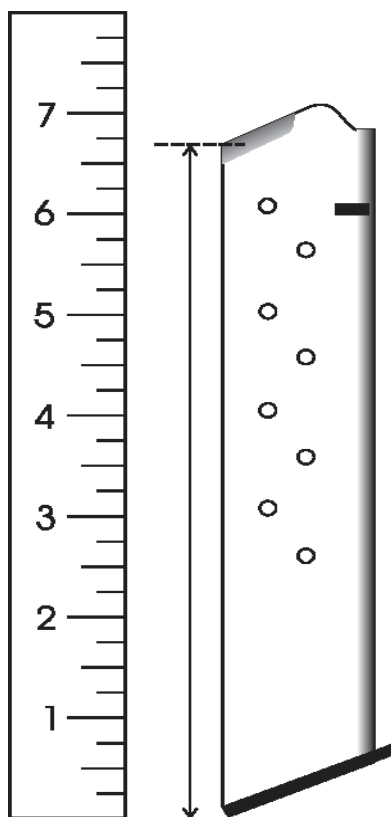

### Magazine Measurement Procedure

Measurements on magazines are as follows:

5.561" (141.25 mm)

6.742" (171.25 mm)

The primary magazine measuring device shall be the EGW mag gauge. A magazine needs to conform to the length limit as well as the gauge to comply with our rules. The gauge width extends to infinity. No curved, collapsible, extendable, or similar types of magazines will be allowed. If a base pad does not conform to the configuration of the gauge, a ruler may be used to measure the overall length as pictured above.

The magazine shall be placed into the gauge without any force or depression. It must lie so that the back of the magazine is flush against the gauge. The follower may be depressed to ensure proper fit.

If the magazine fit or procedure is questioned, the Range Master's call will be final.

## APPENDIX E2

### Example of holster and mag position measurement

(All Divisions)

In accordance with Rule 5.2.5, the maximum lateral distance of the handgun and mag/speedloaders from the inner side of the belt is specified in Appendix D, Item 10.

The measurements displayed below are for illustrative purposes only and do not reflect the maximum allowed.



**Figure A** - This sample measurement shows approximately 1 5/8 inches

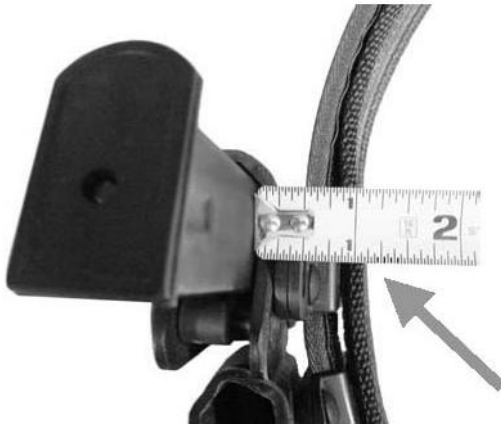

**Figure B** - This sample measurement shows approximately 1 1/8 inch

## APPENDIX E3

### Diagram of Equipment Position

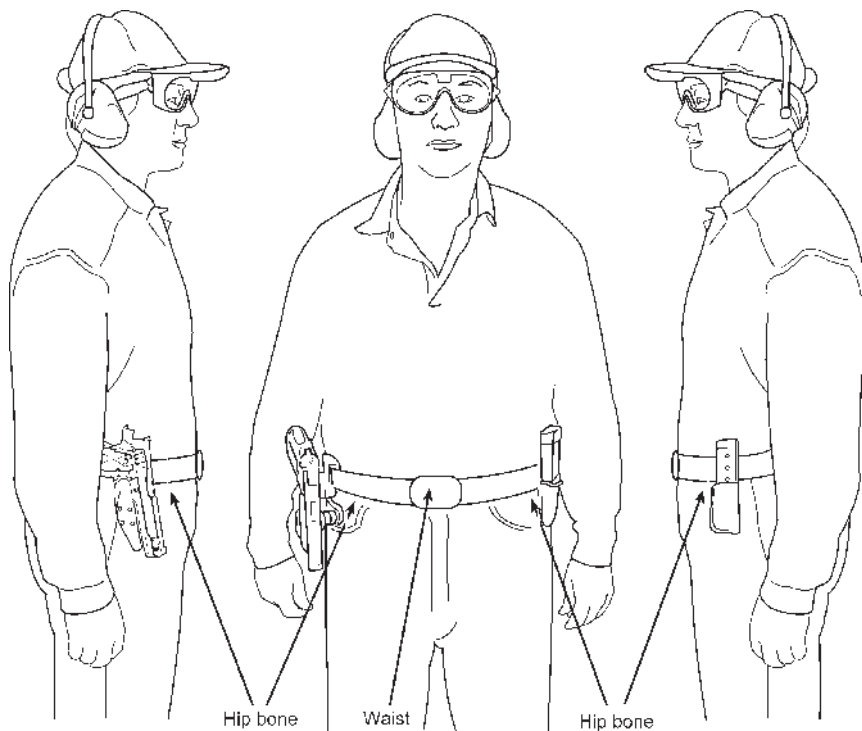

Foremost limit for gun,  
holster and all equipment  
behind the hip bone

This diagram also illustrates “hands and arms naturally at sides”.

## APPENDIX E4

### Checkering, Stippling and/or Application of Grip Tape (Production Division)



Checkering, stippling, and/or tape may only be applied to the areas illustrated by the dashed line boundaries which include the frontstrap and backstrap. Grip Tape cannot be applied to any part of the slide, trigger, trigger guard, or any lever or button. Grip Tape or Grip Sleeves cannot disengage a grip safety.

# APPENDIX F1

## Vendors Area

1. Vendors (i.e. individuals, corporations and other entities displaying or selling merchandise at an USPSA match) are solely responsible for the safe handling and security of their products, and ensuring they are displayed in a condition that must not endanger any person. It is recommended that assembled firearms be deactivated prior to being displayed.
2. The Range Master (in consultation with the Match Director) must clearly delineate the vendor area, and he may issue “Acceptable Practice Guidelines” to all vendors, who are responsible for their implementation in respect of their own merchandise.
3. Competitors may handle unloaded vendor’s firearms while remaining wholly within the vendor areas, provided reasonable care is taken to ensure that the muzzle is not pointed at any person while being handled.
4. Competitors must not draw or re-holster their competition handguns in the vendor area (see Rule 10.5.1). Competitors seeking gunsmithing services for their competition handguns must first place them in a gun bag or gun case, in a designated safety area, before passing them to a vendor in the vendor area.

# INDEX

<b>Subject .....</b>	<b>Section or Rule</b>
Accidental Discharge.....	10.4
Alcohol.....	10.7.2
Ammunition	
Dummy.....	2.4.2 / 10.5.12
Prohibited .....	5.5.3
Spare.....	5.5.2
Unsafe.....	5.5 / 10.5.15
Appeals.....	11.1
Applicability of Rules.....	3.3
Approaching Targets .....	9.1.1
Arbitrations.....	11
Assistance.....	8.6
“Balance: Speed, Accuracy & Power” .....	1.1.3
Barriers .....	2.2 / 2.1.3
Belt	
Attachment .....	5.2.3
Divisions and Regulations.....	App. D
Female .....	5.2.3.1
Broken Firearm.....	5.7
Caliber	
Minimum .....	5.1.2
Divisions.....	App. D
Calibration Ammunition .....	App. C2
Category .....	6.3/App. A2
Changes to Ranges or Equipment .....	2.3 / 3.2.6
Chief Range Officer .....	7.1.2
Chronograph	
Availability .....	5.6.1
Procedures .....	App. C2
Chrono Officer.....	7.1.3
Classic Target .....	App. B2
Classification .....	6.4.2
Classifiers .....	1.2.2.2
Barriers.....	2.2.3
Common Firing Line .....	2.1.7 / 9.4.5.2.1
Competition	
Categories.....	6.3/App. A
Divisions.....	6.2/App. D
General Principles .....	6.1
Match Levels .....	App. A1
Competitor Status and Credentials .....	6.4



Comstock scoring .....	9.2.2
Cooper Tunnel	
Construction .....	2.2.5
Penalties.....	10.2.5
Course Construction	
General Regulations.....	2.1
Criteria.....	2.2
Modification .....	2.3
Course Design – General .....	1.1
Course Information	
General Regulations.....	3.1
Application of Rules.....	3.3
Stage Briefings .....	3.2
Courses of Fire	
Balance .....	1.1.3
Publication.....	3.1
Types.....	1.2
Cover	
Hard.....	4.1.4.1 / 4.2.4 / 4.2.5
Soft.....	4.1.4.2
Creeping .....	10.2.6
Difficulty .....	1.1.6
Disappearing Targets.....	9.9.2 / App. A3
Disqualification .....	10.3
Accidental Discharge.....	10.4
Prohibited Substances .....	10.7
Unsafe Gun Handling.....	10.5
Unsportsmanlike Behavior.....	10.6
Division Deleted .....	6.2.5
Disqualification .....	6.2.6
Failure to Declare .....	6.2.5
Failure to Comply .....	6.2.5.1
More Than One .....	6.2.4
Recognition.....	6.2.1/App. A2
Diversity .....	1.1.4
Dropped Firearm .....	10.5.3/10.5.14
Dropped Magazines.....	5.5.2
Drugs .....	10.7
Duty Rigs.....	5.2.8
DVC .....	1.1.3
Ear Protection .....	5.4
Extra Hits.....	9.4.5.2 / 9.4.6.2
Extra Shots .....	9.4.5.1
Eye Protection .....	5.4
Failure to Shoot At .....	9.5.7
Moving Targets .....	9.9
Penalty .....	10.2.7

Fault Lines.....	2.1.3 / App. A3
Penalties.....	10.2.1 / 10.2.3
Use of.....	2.2.1
Faulting.....	10.2.1
No Shots Fired.....	10.2.1
Shots Fired.....	10.2.1
Firing Line .....	2.1.7 / 9.4.5.2.1
Forbidden Action .....	2.3.1.1 / 3.2.6 / 10.2.11 / App. A3
Frangible Targets .....	4.4
Freestyle .....	1.1.5
Grip Tape.....	App. E4
Handgun	
Auto or Burst.....	5.1.11
Distance From Body.....	5.2.5
Height.....	5.2.7.2
Modification.....	5.1.8
More Than One.....	5.1.9
Muzzle Angle .....	5.2.7.3
Placing on Ground.....	10.5.3
Ready Condition.....	8.1
Ready Position.....	8.2.3
Re-holstering.....	2.2.2.4 / 8.2.5
Replacement.....	5.1.7
Serviceable and safe .....	5.1.6
Shoulder Stocks.....	5.1.10
Tie Down Rigs.....	5.2.7.1
Trigger Pull .....	5.1.4
Unsafe.....	5.7.6
Handling Ammunition.....	10.5.12
Handling of Firearms	
Dropped.....	10.5.14
Safety Area .....	2.4 / 10.5.1
Unsafe.....	10.5.1
Vendor Area .....	App. F1
Hard Cover .....	4.1.4 / 4.2.4 / 4.2.5
Hearing Protection .....	5.4
Holster	
Belt.....	5.2.3
Changing Position .....	5.2.5.3
Choice .....	5.2.6
Covered Trigger .....	5.2.7.4
Duty Rigs .....	5.2.8
Inside a Tunnel .....	10.5.4
Position.....	5.2.5 / App. E2 and E3
Retaining Strap .....	5.2.5.3
Impenetrable Props.....	9.1.6
Impenetrable Targets.....	9.1.5
Interference .....	8.6
Junior Category.....	App. A2

Ladies Category .....	App. A2
Law Category.....	App. A2
League .....	6.1.5
Limited Division .....	App. D2
Limited 10 Division .....	App. D3
Loading.....	App. A3
Location .....	App. A3
Long Courses .....	1.2.1.3
Loaded Firearm.....	10.5.13 / App. A3
Magazines	
Division.....	App. D
Dropped .....	5.5.2
Position .....	App. E2 / App. E3
Spare .....	5.5.2
Major .....	5.6.1.2 / App. D
Malfunctions	
Competitor Equipment.....	5.7
Range Equipment .....	4.6
“Management, Range” .....	7
Match	
Definition .....	6.1.3
Director .....	7.1.7
Officials.....	7.1 / App. A3
Pre-Match.....	6.5.2
Medium Courses .....	1.2.1.2
Membership and Affiliation .....	6.4
Metal Targets .....	4.3 / App. B4 and B5
Metric Target .....	App. B3
Military Category.....	App. A2
Minimum Distance from Metal Targets .....	2.1.3
Minimum Score .....	9.5.6
Minor.....	5.6.1.1
Movement .....	8.5 / App. A3
Moving Targets .....	9.9
Muzzle	
Angle When Holstered.....	5.2.7.3
Direction .....	10.5.2 / 10.5.5 / 10.5.6
No-shoot Hits.....	9.4.2 / 9.4.3
Obstacles.....	2.1.6 / 2.2.2
Official Match Ammunition .....	5.8
Official Times .....	9.1
Off-Limits Lines.....	2.2.1.5 / 2.3.1.1 c / App. A3
Open Division.....	App. D1
Penalties.....	10
Penalty in Lieu of Requirement .....	10.2.10
Plates .....	4.3/App. B5
Poppers	
Dimensions and Scoring .....	App. B4
Operation and Calibration .....	App. C1

Targets .....	4.3
Power.....	1.1.3
Power Factor.....	5.6
Procedural Penalties .....	10
Assistance/Interference.....	8.6
Cooper Tunnels .....	10.2.5
Creeping .....	10.2.6
Failure to Engage.....	10.2.7
Faulting .....	10.2.1
Mandatory Reload .....	10.2.4
Stage Procedure.....	10.2.2
Strong Hand – Weak Hand .....	10.2.8
Targets – Approaching/Touching.....	9.1.1 / 9.1.2
Production Division.....	App. D4
Prohibited Substance .....	10.7
Protest Fee	
Amount .....	11.4.1
Forfeited .....	11.4.2
Protest Time Limit.....	11.3
Published Courses.....	3.1.1
Quartermaster .....	7.1.5
Radial Tears.....	9.5.4
Range	
Changes .....	2.3
Commands.....	8.3
Equipment Failure .....	4.6
Management .....	7
Master.....	7.1.6
Officer.....	7.1.1
Procedures	
False Start .....	8.3.4.1
Sight Pictures.....	8.7
Procedure Change/Revision .....	3.2.3
Surface .....	2.1.5 / 4.5
Ready Conditions – Handgun .....	8.1
Ready Position – Competitor.....	8.2
Recognition of Divisions and Categories.....	App. A2
Re-holster .....	8.2.5 / 8.5.2
Reengagement .....	10.2.9
Reloading.....	8.4 / App. A3
Remedial Action .....	App. A3
Replacement Handgun .....	5.1.7
Reshoot.....	2.3.3 / 3.2.6.1 / 4.3.1 / 4.6.2 / 5.4.3 / 5.7.7.2 / 8.2.2 / 8.6.4 / 9.1 / 9.7 / 9.10 / App. A3 / App. C1 6&7
Reshoot – not permitted .....	5.7.6 / 5.7.7.1 / 5.8.1.2 / 8.6.1
Re-shoot Refusal by Competitor .....	2.3.3.3
Revolver	
Division.....	App. D6

Following Course of Fire.....	8.3.7
Ready Condition.....	8.1.1
Placing on Ground.....	10.5.3
Rounds Loaded .....	8.1.4
Safety	
Course Design .....	1.1.1
Glasses .....	5.4
Handguns .....	5.1.6
Host's Responsibilities .....	2.1.1
Safety Area.....	2.4.1
Construction .....	2.4
Live or Dummy Ammunition.....	2.4.2
Sanctioning .....	1.3
Scaling Aids.....	2.2.2
Schedule .....	6.5
Score Sheets.....	9.7
Changes .....	9.7.4, A3
Corrections .....	9.7.2, A3
Scoring	
Methods .....	9.2
Misses .....	9.4.4
Penalties .....	10
Policy .....	9.5
Programs .....	9.11
Responsibility.....	9.8
Values .....	9.4
Verification .....	9.6
Senior Category .....	App. A2
Shooting Box (also see Fault Line).....	2.2.1 / App. A3
Short Courses.....	1.2.1.1
Shoulder Stocks .....	5.1.10
Sight Picture.....	8.7 / App. A3
Sights.....	5.1.3
Single-Stack Division.....	App. D5
Soft Cover.....	4.1.4.2
Special Penalty.....	10.2.10
Speed Shoot .....	1.2.2.3
Speedloaders .....	5.2.4 / 5.2.5 / 5.5.2
Squib.....	5.7.7 / 10.5.15.1 / App. A3
Stage.....	6.1.2
Stage Briefings	
Information.....	3.2.1
Changes or Modification .....	3.2.3
Stage Points .....	9.2.2.1 / 9.2.3.1 / 9.2.4.1 / 9.2.6
Standard Exercises .....	1.2.2.1
Standby.....	8.3.3
Stats Officer.....	7.1.4
String.....	6.1.1
Strong Hand .....	1.1.5.3 / 1.1.5.4 / 1.1.5.5 / App. A3

Super Senior Category .....	App. A2
Sweeping .....	10.5.5 / App. A3
Targets	
Angle.....	2.1.8.4
Approaching .....	9.1.1
Authorized.....	4.1.1
Dimensions.....	App. B
Disappearing/Moving .....	9.9
Frangible .....	4.4
Impenetrable.....	9.1.5
Malfunction.....	4.6
Maximum Hits Before Scoring .....	4.2.3
Placement .....	2.1.8
Prematurely Patched .....	9.1.3
Scoring Challenge .....	9.4 / 9.5
Sticks .....	9.1.7
Touching .....	9.1.2
Un-restored .....	9.1.4
Tie Down Rigs .....	5.2.7.1 / App. A3
Ties .....	9.3
Timing Devices .....	9.10
Tournament.....	6.1.4
Tunnels.....	2.2.4
Unsafe Gun Handling .....	10.5
Unsportsmanlike Conduct .....	10.6
USPSA Membership.....	6.4.1
View .....	App. A3.
Vendor Areas.....	App. F1
Virginia Count	
Penalties.....	9.4.5
Scoring.....	9.2.3
Weak Hand .....	1.1.5.3/ 1.1.5.4/ 1.1.5.5 / App. A3
Draw.....	8.2.4
Zero Score .....	2.3.3.3/ 6.5.1 /9.5.6 /9.7.6.1 / 9.7.7/9.10.3/10.2.11



## Scoring Targets

- #1 NS
- #2 C NS
- #3 C NS
- #4 A NS
- #5 A
- #6 C NS
- #7 D NS
- #8 NS

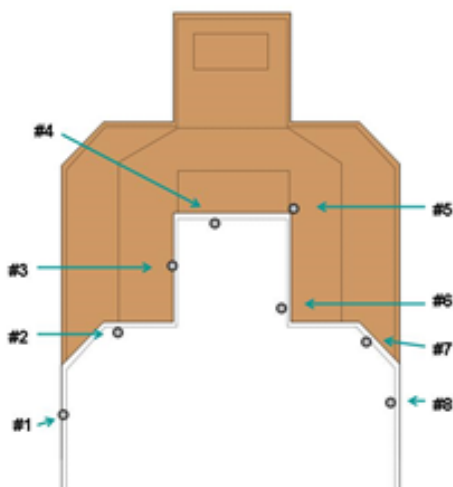

## Target Scoring

- Hits touching the scoring line between two scoring areas or the line between the non-scoring border and a scoring area, **score the higher value**

**Use your overlays**

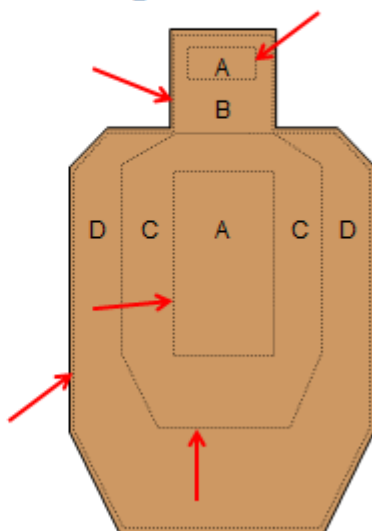

## Addendum to the 2014 USPSA Handgun Competition Rules, February 2014.

### Pistol Caliber Carbine

**All references to “handgun” in the current edition of the rulebook are deemed to apply to PCC as well, except where PCC is noted in the rules. NO UPRANGE STARTS WHILE HOLDING THE CARBINE.**

**NOTE: This applies to classifier requirements in all instances.**

PCC 5.1.11 Full auto/burst fire triggers are allowed, but may only be used in semi-auto mode. See PCC 10.5.18; Appendix D8, #15.

PCC 5.1.12 See appendix D8. Binary Triggers, (any trigger system that allows one round to be fired upon pulling the trigger and another on releasing the trigger) are prohibited. See PCC 10.5.18; Appendix D8, #16. All other handgun equipment rules apply to PCC.

PCC 5.2.1 Except when within the boundaries of a safety area, or when under the supervision and direct command of a Range Officer, competitors must carry their pistol caliber carbine:

PCC 5.2.1.1 Detachable magazines removed.

PCC 5.2.1.2 Competitors must use a chamber safety flag, or clear chamber device, that is easily visible externally to the gun when transporting from vehicles or stage to stage. Anyone found in violation of this rule will be immediately escorted by a Range Officer to a suitable range or safety area where appropriate corrective action shall be made.

PCC 5.2.1.3 Un-cased pistol caliber carbines must be carried shouldered or slung from the shoulder or held in the hands with the firearm reasonably vertical and a chamber safety flag in place. Match Directors may require this to be "vertically upwards" or "vertically downwards" providing this is made clear to all competitors in a reasonable manner.

PCC 5.2.1.4 Pistol caliber carbines may be transported or stored without a slip or case, whether or not reasonably vertical, in a mobile rack or carrier as long as a chamber safety flag is used.

PCC 5.2.1.5 Match organizers may specify that carbines are allowed to be cased or uncased with the muzzle in a safe direction, i.e., into the side berm or backstop. This can be designated as a “staging area” for carbines. No handgun handling is allowed in this area. When casing/uncasing PCC’s, the muzzle must point at a side berm or backstop. Failure to point the muzzle at a side berm or back stop during casing/uncasing will result in a DQ per PCC 10.5.2.1

PCC 5.2.1.6 Transporting pistol caliber carbines from the staging area to the start position and back to the staging area from where the shooter unloads and shows clear, the gun must be carried muzzle up or muzzle down with the bolt closed on a chamber safety flag.

PCC 6.2.5.1 If a competitor fails to satisfy the equipment or other requirements for PCC division during the course of fire, he will shoot for no score.



PCC 8.1.6 PCC Ready Condition: normally the carbine will be prepared with a loaded chamber, loaded magazine inserted, and safety applied. Other ready conditions may be specified, and may be identical to the handgun ready condition, with the exception of holstering.

PCC 8.2.3 (Pistol rules about touching the gun are N/A for carbines.) Fingers must be outside the trigger guard and the safety applied if the carbine is loaded. Competitors are not allowed to start touching or holding ammunition, loading devices, magazines, etc., or with the safety in the off position. *Note: For purposes of this rule, safety on is considered part of the start position. See 8.3.1*

PCC 8.2.4 A course of fire must never require a competitor to start with the carbine held on the weak side.

PCC 8.2.5.1 A course of fire must never require a competitor to place his PCC in any location after the start signal. However, a competitor may place his PCC on any stable object provided this is accomplished in a safe manner and the PCC is unloaded or in a ready condition as stated in section 8.1.

PCC 8.3.7.1 **“If clear, hammer down, flag”**. While continuing to point the carbine safely downrange, the competitor must perform a final safety check of the carbine by closing the bolt on an empty chamber, pulling the trigger, and then inserting the chamber flag. The carbine must then be transported with the muzzle reasonably vertically up or down, while scoring is done, and then off the stage to a rack or case. Flagged carbines may also be cased at this time and transported off the stage in the case. When casing PCC’s, the muzzle must point at a side berm or backstop. Failure to point the muzzle at a side berm or back stop during casing will result in a DQ per PCC 10.5.2.1

PCC 10.5.2.1 Failing to point the muzzle at a side berm or back stop during casing or uncasing, or sweeping any person with the muzzle of an uncased PCC, whether loaded or not, even if a chamber flag is inserted. Side berms/backstops may be used for casing and uncasing only. All other gun handling with the PCC, e.g., sight pictures, turning dots on/off, etc., must be accomplished in a safety area or under the direct supervision of a Range Officer.

PCC 10.5.18 Firearms capable of fully automatic or burst fire, (one trigger pull results in firing more than one shot, and stocks or other devices that are capable of bump fire are not prohibited, providing they are not used in full auto, burst, or bump fire mode. Binary triggers (one pull and release of the trigger results in firing more than one shot), are prohibited. Use of such devices in full auto, burst, binary or bump fire mode, will result in a procedural penalty for the first occurrence, and a disqualification for any subsequent infractions. Bump firing without mechanical aid is not penalized, provided there are no other equipment or safety infractions, the PCC is not doubling, and it can be safely fired in semi-auto mode.

PCC Appendix A3: All references to “strong hand” and “weak hand” in the current edition of the rulebook apply to PCC as follows: Strong Hand will require the PCC to be shouldered on the strong hand side, trigger pulled with the strong hand. Both hands may be on the gun. Weak Hand will require the PCC to be shouldered on the weak side, trigger pulled with the weak hand. Both hands may be on the gun. Course descriptions may never require the carbine to be fired using only one hand. NO UPRANGE STARTS WHILE HOLDING THE CARBINE.